

DTCXO Temperature Compensated Real Time Clock Module with I²C Bus

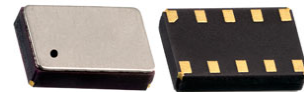

3.7 x 2.5 x 0.9 mm

AB-RTCMC-32.768kHz-EOZ9-S3



RoHS/RoHS II compliant

Moisture Sensitivity Level: MSL=1

FEATURES:

- RTC module with built-in “Tuning Fork” crystal oscillating at 32.768 kHz
- Factory calibrated, all built-in Temperature Compensation circuitry Time accuracy Option A & B. See Part Identification on page 7 for details
- Ultra low power consumption: 800nA typ @ VDD = 3.0V / Tamb = 25°C
- Wide clock operating voltage: 1.3 – 5.5V
- Wide interface operating voltage: 1.4 – 5.5V
- Extended operating temperature range: -40°C to +125°C
- I2C serial interface with fast mode SCL clock frequency of 400kHz
- Provides year, month, day, weekday, hours, minutes and seconds
- Highly versatile alarm and timer functions
- Integrated Low-Voltage Detector, Power-On Reset and Self-Recovery System
- Main Power Supply to Backup Battery switchover circuitry with Trickle Charger
- Programmable CLKOUT pins for peripheral devices (32.768 kHz / 1024 Hz / 32 Hz / 1 Hz)
- Small and compact package size: 3.7 x 2.5 x 0.9 mm. RoHS-compliant and 100% leadfree

APPLICATIONS:

- Wide range in communication & measuring equipment
- Commercial & Industrial applications
- Automotive electronics applications
- Wireless communications
- PDA and Palm Pilots
- Credit Cards with Security Technology

STANDARD SPECIFICATIONS:

Absolute Maximum Ratings

Parameters	Min.	Typ.	Max.	Units	Notes
Supply Voltage (V _{DD})	GND-0.3		+6.0	V	>GND / <V _{DD}
Supply Current (I _{DD} ; I _{SS})	-50		+50	mA	V _{DD} Pin
Input Voltage (V _I)	GND-0.3		V _{DD} +0.3	V	Input Pin
Output Voltage (V _O)	GND-0.5		V _{DD} +0.5	V	$\overline{\text{INT}}$ /CLKOUT
DC Input Current (I _I)	-10		+10	mA	
DC Output Current (I _O)	-10		+10	mA	
Total Power Dissipation (P _{TOT})			300	mW	
Operating Temperature Range (T _{OPR})	-40		+125	°C	
Storage Temperature (T _{STO})	-55		+125	°C	Stored as bare product

Frequency and Time Characteristics

V_{DD}=3.0V; V_{SS}=0V; T_{AMB}=+25°C; f_{OSC}=32.768kHz

Parameters	Min.	Typ.	Max.	Units	Notes
32.768kHz Oscillator Characteristics					
Frequency Accuracy (ΔF/F)		±10	±20	ppm	F _{CLKOUT} =32.768kHz; T _{AMB} =+25°C; V _{DD} =3.0V
Frequency vs Voltage (ΔF/V)		±0.5	±1.0	ppm/V	T _{AMB} =+25°C; V _{DD} =1.4~5.5V
Frequency vs Temperature (ΔF/T _{OPR})	-0.035ppm/°C ² (T _{OPR} -T _O) ² ±10%			ppm	T _{OPR} =-40~+125°C; V _{DD} =3.0V
Turnover Temperature (T _O)	+20	+25	+30	°C	
Aging (first year)	-3		+3	ppm	T _{AMB} =+25°C
Start-up Time Voltage (V _{START})					
Start-up Time (T _{START})		0.5	3	s	T _{AMB} =-40 ~ +85°C
		1	3		T _{AMB} =-40 ~ +125°C
CLKOUT duty cycle	40	50	60	%	F _{CLKOUT} =32.768kHz; T _{AMB} =+25°C

DTCXO Temperature Compensated Real Time Clock Module with I²C Bus

AB-RTCMC-32.768kHz-EOZ9-S3



RoHS/RoHS II compliant

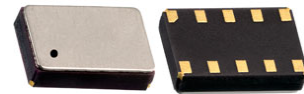

3.7 x 2.5 x 0.9 mm

(Continued)

Parameters		Min.	Typ.	Max.	Units	Notes
Time accuracy, DTCXO Digitally Temperature Compensated						
Time Accuracy Option: A ($\Delta t/t$)	$T_{AMB}=+25^{\circ}\text{C}$		± 1	± 3	ppm	
	$T_{AMB}=0 \sim +50^{\circ}\text{C}$		± 2	± 4		
	$T_{AMB}=-10 \sim +65^{\circ}\text{C}$		± 3	± 5		
	$T_{AMB}=-40 \sim +85^{\circ}\text{C}$		± 4	± 6		
	$T_{AMB}=-40 \sim +125^{\circ}\text{C}$		± 5	± 8		
Time Accuracy Option: B ($\Delta t/t$)	$T_{AMB}=+25^{\circ}\text{C}$		± 1	± 3	ppm	
	$T_{AMB}=0 \sim +50^{\circ}\text{C}$		± 3	± 5		
	$T_{AMB}=-10 \sim +65^{\circ}\text{C}$		± 5	± 10		
	$T_{AMB}=-40 \sim +85^{\circ}\text{C}$		± 10	± 25		
	$T_{AMB}=-40 \sim +125^{\circ}\text{C}$		± 15	± 30		

Static Characteristics

$V_{DD}=1.4\sim 5.5\text{V}$; $V_{SS}=0\text{V}$; $T_{AMB}=-40^{\circ}\text{C} \sim +125^{\circ}\text{C}$; $f_{OSC}=32.768\text{kHz}$

Parameters		Min.	Typ.	Max.	Units	Notes
Supplies						
Supply Voltage (V_{DD})		1.4		5.5	V	Time-keeping mode I ² C bus reduced speed
		2.1		5.5		I ² C bus full speed
Minimum Supply Voltage Detection (V_{LOW1})		1.8		2.1	V	$T_{AMB}=-40 \sim +125^{\circ}\text{C}$
Minimum Supply Voltage Detection (V_{LOW2})		1.0		1.4	V	$T_{AMB}=-40 \sim +125^{\circ}\text{C}$
Main Supply to Backup Supply Switchover Hysteresis (V_{HYST})			20		mV	V_{DD} to $V_{BACK} = 3.0\text{V}$
Supply Current I_{DD} ($V_{BACK}=0\text{V}$) or I_{BACK} ($V_{DD}=0\text{V}$)	$V_{DD}=1.4\text{V}$ $T_{AMB}=-40^{\circ}\text{C} \sim +85^{\circ}\text{C}$		0.6	1.5	μA	SPI bus inactive CLKOUT disabled $V_{BACK}=0\text{V}$ Or $V_{DD}=0\text{V}$
	$V_{DD}=1.4\text{V}$ $T_{AMB}=-40^{\circ}\text{C} \sim +125^{\circ}\text{C}$			4.6		
	$V_{DD}=3.3\text{V}$ $T_{AMB}=-40^{\circ}\text{C} \sim +85^{\circ}\text{C}$		0.8	2.0		
	$V_{DD}=3.3\text{V}$ $T_{AMB}=-40^{\circ}\text{C} \sim +125^{\circ}\text{C}$			5.2		
	$V_{DD}=5.0\text{V}$ $T_{AMB}=-40^{\circ}\text{C} \sim +85^{\circ}\text{C}$		0.9	2.2		
	$V_{DD}=5.0\text{V}$ $T_{AMB}=-40^{\circ}\text{C} \sim +125^{\circ}\text{C}$			5.5		

DTCXO Temperature Compensated Real Time Clock Module with I²C Bus

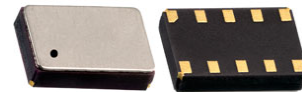

AB-RTCMC-32.768kHz-EOZ9-S3



RoHS/RoHS II compliant

3.7 x 2.5 x 0.9 mm

(Continued)

Parameters		Min.	Typ.	Max.	Units	Notes
Supply Current (I _{DD})	SCL= 200kHz V _{DD} = 1.4V T _{AMB} = -40°C ~ +85°C			14	μA	SPI bus active CLKOUT disabled
	SCL= 200kHz V _{DD} = 1.4V T _{AMB} = -40°C ~ +125°C			18		
	SCL= 1MHz V _{DD} = 3.3V T _{AMB} = -40°C ~ +85°C			50		
	SCL= 1MHz V _{DD} = 3.3V T _{AMB} = -40°C ~ +125°C			55		
	SCL= 1MHz V _{DD} = 5.0V T _{AMB} = -40°C ~ +85°C			65		
	SCL= 1MHz V _{DD} = 5.0V T _{AMB} = -40°C ~ +125°C			75		
Current Consumption (I _{DD32K})	V _{DD} =5.0V		2.5	3.4	μA	SPI bus inactive CLKOUT =32.768kHz C _{LOAD} =7.5pF
	V _{DD} =3.3V		1.5	2.2		
	V _{DD} =1.4V		1.1	1.6		
Input						
LOW Level Input Voltage (V _{IL})				20%* V _{DD}	V	V _{DD} = 1.4 ~ 5.5V _{DD} Pins:SCL,SDI,CLKOE,CE
HIGH Level Input Voltage (V _{IH})		80%* V _{DD}			V	
Input Leakage Current (I _L)	T _{amb} =-40 ~+85°C	-1		+1	μA	V _{SS} >V _I <V _{DD}
	T _{amb} =-40 ~+125°C	-1.5		+1.5		
Input Capacitance (C _I)				7	pF	

DTCXO Temperature Compensated Real Time Clock Module with I²C Bus

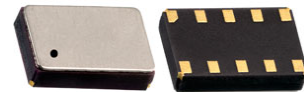

3.7 x 2.5 x 0.9 mm

AB-RTCMC-32.768kHz-EOZ9-S3



RoHS/RoHS II compliant

(Continued)

Parameters		Min.	Typ.	Max.	Units	Notes
Output						
HIGH Level Output Voltage (V_{OH})	$V_{DD} = 1.4V; I_{OH} = 0.1mA$	1.0			V	
	$V_{DD} = 3.3V; I_{OH} = 1.5mA$	2.7				
	$V_{DD} = 5.0V; I_{OH} = 2.0mA$	4.5				
LOW Level Output Voltage (V_{OL})	$V_{DD} = 1.4V; I_{OL} = 0.4mA$			0.2	V	
	$V_{DD} = 3.3V; I_{OL} = 1.5mA$			0.25		
	$V_{DD} = 5.0V; I_{OL} = 5.0mA$			0.8		
HIGH Level Output Current (I_{OH})	$V_{OH} = 4.5V / V_{DD} = 5V$			2.0	mA	
LOW Level Output Current (I_{OL})	$V_{OL} = 0.8V / V_{DD} = 5V$			-5.0	mA	
Output Leakage Current (I_{LO})	$V_O = V_{DD} \text{ or } V_{SS}$ $T_{AMB} = -40^{\circ}C \sim +85^{\circ}C$	-1	0	+1	μA	
	$V_O = V_{DD} \text{ or } V_{SS}$ $T_{AMB} = -40^{\circ}C \sim +125^{\circ}C$	-1.5	0	+1.5		
Operating Temperature Range						
Operating Temperature Range (T_{OPR})		-40		+125	$^{\circ}C$	
EEPROM Characteristics						
Read Voltage (V_{Read})	$T_{AMB} = -40^{\circ}C \sim +125^{\circ}C$	1.4			V	
Programming Voltage (V_{Prog})	$T_{AMB} = -40^{\circ}C \sim +125^{\circ}C$	2.2			V	
EEPROM Programming Time (T_{Prog})	$T_{AMB} = -40^{\circ}C \sim +125^{\circ}C$ 1 Byte EEPROM User			35	ms	
	$T_{AMB} = -40^{\circ}C \sim +125^{\circ}C$ 1 Byte EEPROM Control			100		
	$T_{AMB} = -40^{\circ}C \sim +125^{\circ}C$ 2-4 Byte EEPROM Control			135		
EEPROM Write/Erase Cycles (V_{HYST})	$V_{DD} \text{ to } V_{BACK} = 3.0V$	5000			Cycles	

DTCXO Temperature Compensated Real Time Clock Module with I²C Bus

AB-RTCMC-32.768kHz-EOZ9-S3



RoHS/RoHS II compliant

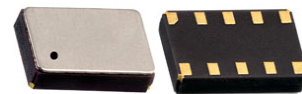

3.7 x 2.5 x 0.9 mm

(Continued)

Parameters		Min.	Typ.	Max.	Units	Notes
Trickle Charger						
Current Limiting Resistors	R80K		80		kΩ	V _{DD} = 5.0V V _{BACK} = 3.0V T _{AMB} = 25°C
	R20k		20			
	R5k		5			
	R1.5k		1.5			
Thermometer						
Thermometer Precision (T _E)	T _{AMB} = -40°C ~ +85°C		±4		°C	
	T _{AMB} = -40°C ~ +125°C		±6			

I²C Interface Dynamic Characteristics

V_{SS}=0V; T_{AMB}=-40°C ~+125°C; All timing values are valid within the operating supply voltage range and references to V_{IL} and V_{IH} with an input voltage swing from V_{SS} and V_{DD}.

Parameters	Min.	Typ.	Max.	Units	Conditions
SCL Clock Frequency (f _{SCL})			100	kHz	V _{DD} ≥ 1.4V
			300		V _{DD} ≥ 1.8V
			400		V _{DD} ≥ 3.0V
Start Condition Set-up Time (t _{SU; STA})	50			μs	V _{DD} ≥ 1.4V
	30				V _{DD} ≥ 1.8V
	20				V _{DD} ≥ 3.0V
Start Condition Hold Time (t _{HD; STA})	0.2			μs	V _{DD} ≥ 1.4V
					V _{DD} ≥ 1.8V
					V _{DD} ≥ 3.0V
Data Set-up Time (t _{SU; DAT})	100			ns	V _{DD} ≥ 1.4V
	80				V _{DD} ≥ 1.8V
	50				V _{DD} ≥ 3.0V
Data Hold Time (t _{HD; DAT})	50			ns	V _{DD} ≥ 1.4V
	30				V _{DD} ≥ 1.8V
	20				V _{DD} ≥ 3.0V
Data Valid Time (t _{VD; DAT})	4.0			μs	V _{DD} ≥ 1.4V
	1.5				V _{DD} ≥ 1.8V
	1.2				V _{DD} ≥ 3.0V
Data Valid Acknowledge Time (t _{VD; ACK})	3.5			μs	V _{DD} ≥ 1.4V
	1.1				V _{DD} ≥ 1.8V
	0.9				V _{DD} ≥ 3.0V

DTCXO Temperature Compensated Real Time Clock Module with I²C Bus

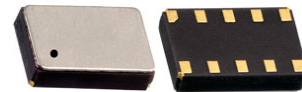

3.7 x 2.5 x 0.9 mm

AB-RTCMC-32.768kHz-EOZ9-S3



RoHS/RoHS II compliant

(Continued)

Parameters	Min.	Typ.	Max.	Units	Conditions
Stop Condition Set-up Time ($t_{SU; STO}$)	50			ns	$V_{DD} \geq 1.4V$
	30				$V_{DD} \geq 1.8V$
	20				$V_{DD} \geq 3.0V$
Bus Free Time between STOP and START Condition (t_{BUF})	1.0			μs	$V_{DD} \geq 1.4V$
	0.5				$V_{DD} \geq 1.8V$
	0.4				$V_{DD} \geq 3.0V$
SCL "LOW time" (t_{LOW})	4.5			μs	$V_{DD} \geq 1.4V$
	1.7				$V_{DD} \geq 1.8V$
	1.3				$V_{DD} \geq 3.0V$
SCL "High time" (t_{HIGH})	0.6			μs	$V_{DD} \geq 1.4V$
	0.5				$V_{DD} \geq 1.8V$
	0.4				$V_{DD} \geq 3.0V$
SCL and SDA Rise Time (t_r)			1.0	μs	$V_{DD} \geq 1.4V$
			0.3		$V_{DD} \geq 1.8V$
			0.2		$V_{DD} \geq 3.0V$
SCL and SDA Fall Time (t_f)			0.4	μs	$V_{DD} \geq 1.4V$
			0.3		$V_{DD} \geq 1.8V$
			0.2		$V_{DD} \geq 3.0V$
Tolerance Spike Time on Bus (t_{SP})			50	ns	
SCL and SDA I/O Capacitance ($C_{I/O}$)			10	pF	
Capacitive Load Bus Lines (C_B)			200	pF	

I²C Interface Timing Characteristics

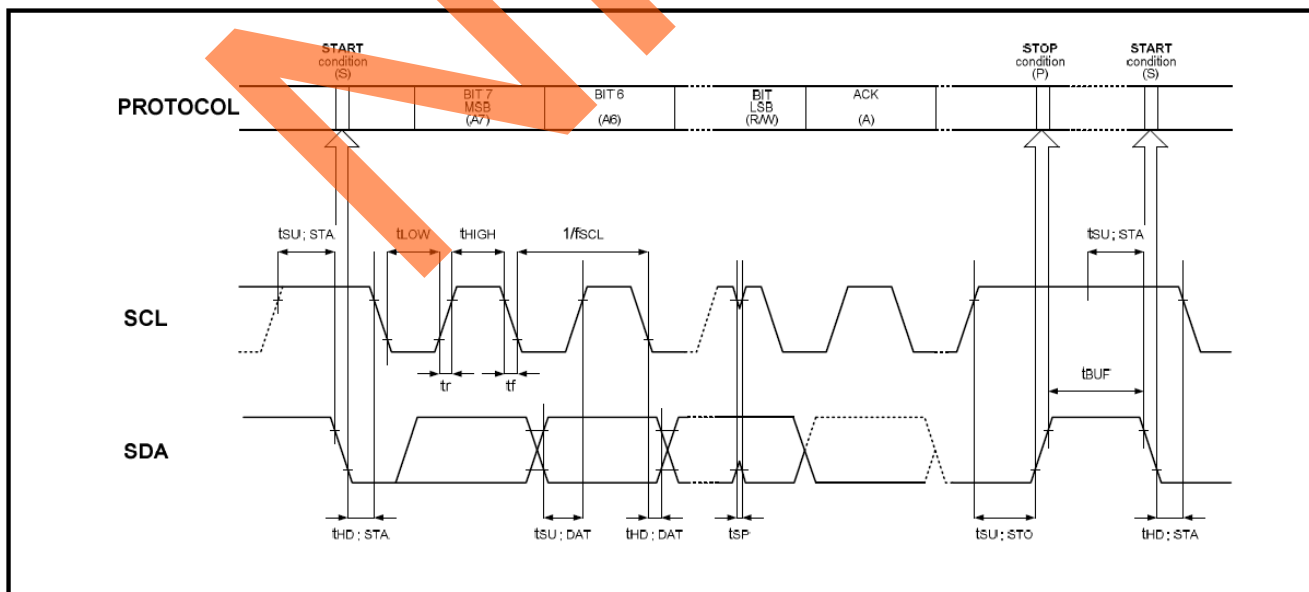

DTCXO Temperature Compensated Real Time Clock Module with I²C Bus

AB-RTCMC-32.768kHz-EOZ9-S3



RoHS/RoHS II compliant

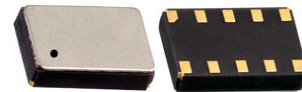

3.7 x 2.5 x 0.9 mm

PART IDENTIFICATIONS:

AB-RTCMC-32.768 kHz-EOZ9-S3-

Operating Temp. Range
D: -40 ~ +85°C
H: -40 ~ +125°C

Timing Accuracy
A: see Table 1 below
B: see Table 1 below

Packaging
Blank: Bulk
T: 1000pcs/reel

Table 1. Time accuracy, DTCXO Digitally Temperature Compensated

Parameters		Min.	Typ.	Max.	Units
Time Accuracy Option: A	T _{AMB} =+25°C		±1	±3	ppm
	T _{AMB} =0 ~ +50°C		±2	±4	
	T _{AMB} =-10 ~ +65°C		±3	±5	
	T _{AMB} =-40 ~ +85°C		±4	±6	
	T _{AMB} =-40 ~ +125°C		±5	±8	
Time Accuracy Option: B	T _{AMB} =+25°C		±1	±3	ppm
	T _{AMB} =0 ~ +50°C		±3	±5	
	T _{AMB} =-10 ~ +65°C		±5	±10	
	T _{AMB} =-40 ~ +85°C		±10	±25	
	T _{AMB} =-40 ~ +125°C		±15	±30	

OUTLINE DIMENSIONS:

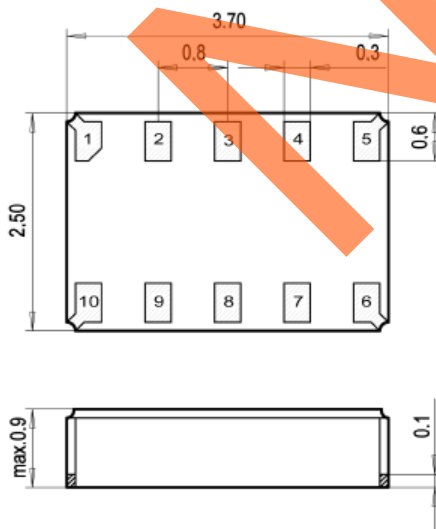

Recommended Land Pattern

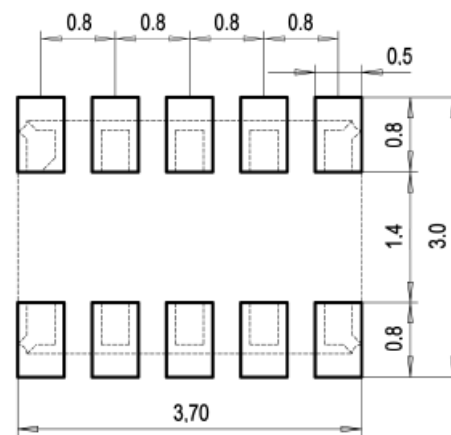

Dimensions: mm

DTCXO Temperature Compensated Real Time Clock Module with I²C Bus

AB-RTCMC-32.768kHz-EOZ9-S3



RoHS/RoHS II compliant

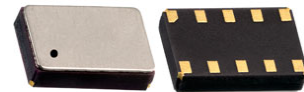

3.7 x 2.5 x 0.9 mm

PIN DESCRIPTIONS:

Pin No.	Pin Name	Function
1	CLKOE	CLKOUT enable/disable pin; enable is active HIGH; tie to GND when not using CLKOUT
2	V _{DD}	Positive supply voltage; positive or negative steps in supply voltage may affect oscillator performance, recommend 10 nF decoupling capacitor close to device
3	CLKOUT	Clock Output pin; CLKOUT or $\overline{\text{INT}}$ function can be selected.(Control_1; bit7; Clk/Int) CLKOUT output push-pull / $\overline{\text{INT}}$ function open-drain requiring pull-up resistor
4	SCL	Serial Clock Input pin; requires pull-up resistor
5	SDA	Serial Data Input-Output pin; open-drain; requires pull-up resistor
6	V _{SS}	Ground
7	$\overline{\text{INT}}$	Interrupt output pin; open-drain; active LOW
8	N.C.	Not connected; internally used for test. do not connect other signals than ground
9	V _{BACKUP}	Backup Supply Voltage; tie to GND when not using backup supply voltage
10	N.C.	Not connected; internally used for test. do not connect other signals than ground

BLOCK DIAGRAM:

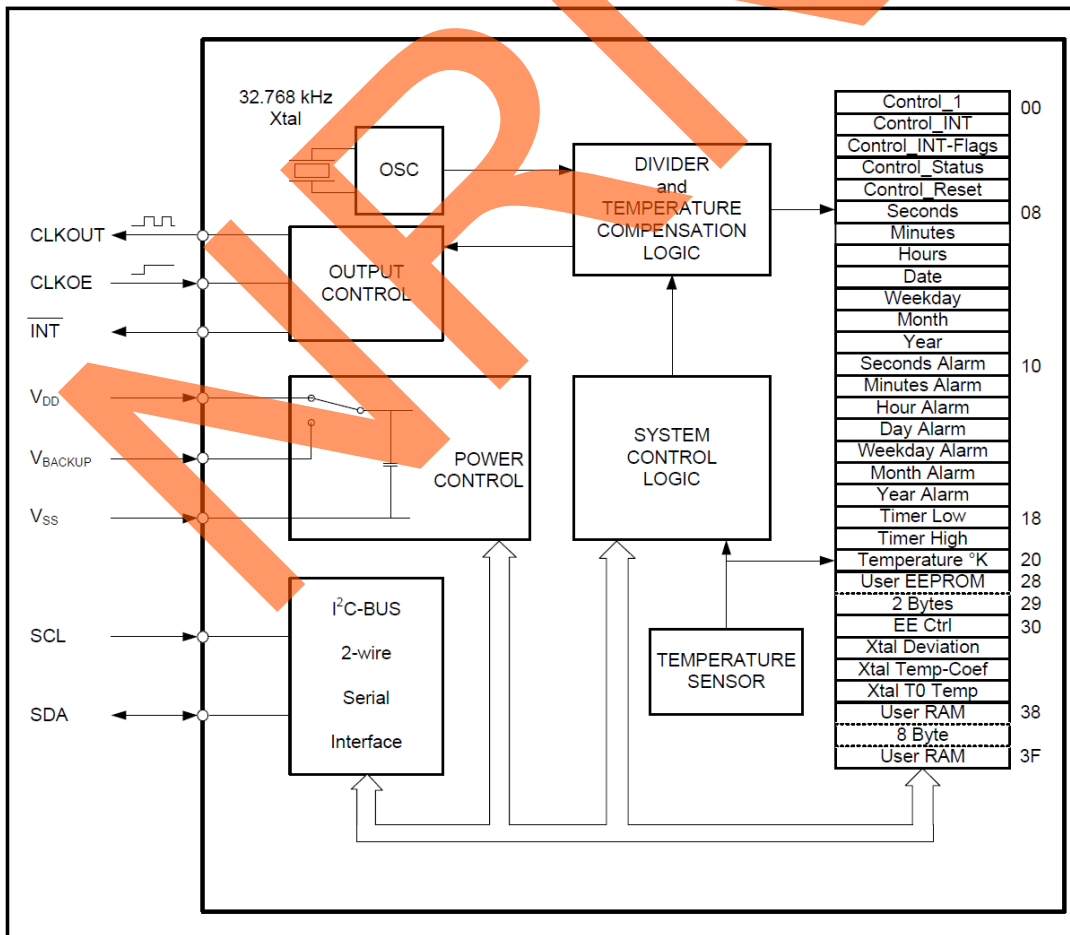

DTCXO Temperature Compensated Real Time Clock Module with I²C Bus

AB-RTCMC-32.768kHz-EOZ9-S3



RoHS/RoHS II compliant

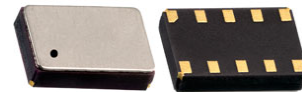

3.7 x 2.5 x 0.9 mm

RECOMMENDED REFLOW PROFILE:

Maximum Reflow Conditions in accordance with IPC/JEDEC J-STD-020C "Pb-free"

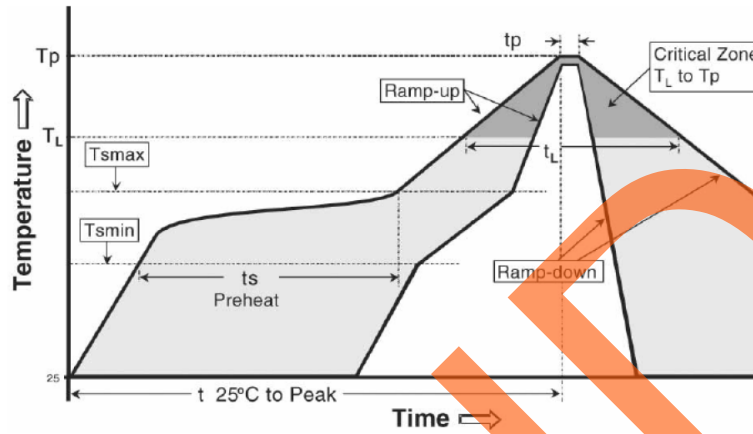

Temperature	Conditions	Units
Average Ramp-up Rate (T_{Smax} to T_p)	3°C/second max	°C/s
Ramp Down Rate (T_{cool})	6°C/second max	°C/s
Time 25°C to Peak Temperature ($T_{to-peak}$)	8 minutes max	m
Preheat		
Temperature Min (T_{Smin})	150	°C
Temperature Max (T_{Smax})	200	°C
Time T_{Smin} to T_{Smax} (t_s)	60 ~ 180	sec
Time Above Liquidus		
Temperature Liquidus (T_L)	217	°C
Time above Liquidus (t_l)	60 ~ 150	sec
Peak Temperature		
Peak Temperature (T_p)	260	°C
Time within 5°C of Peak Temperature (t_p)	20 ~ 40	sec

DTCXO Temperature Compensated Real Time Clock Module with I²C Bus

AB-RTCMC-32.768kHz-EOZ9-S3



RoHS/RoHS II compliant

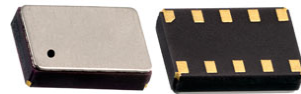

3.7 x 2.5 x 0.9 mm

TAPE & REEL:

T = 1000pcs/reel

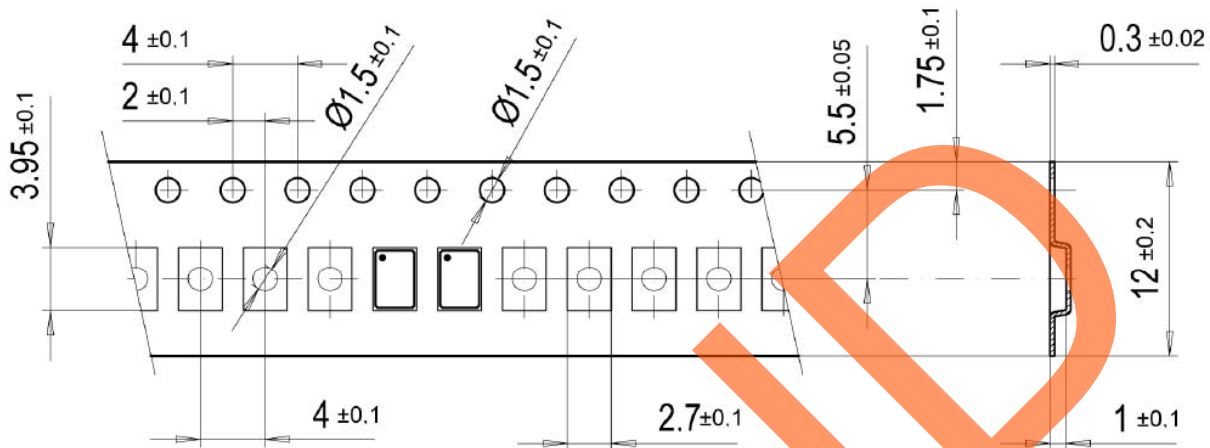

User Direction of Feed

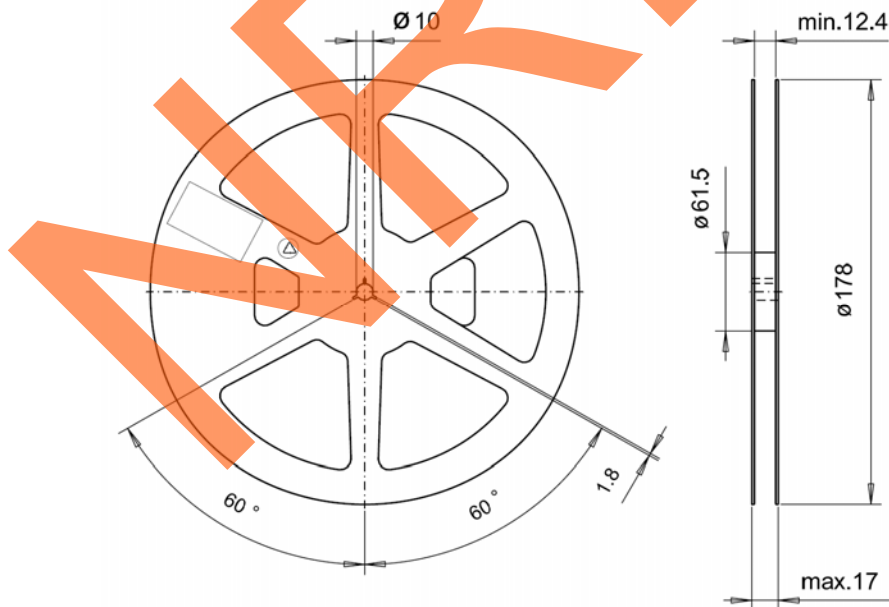

Dimension: mm

ATTENTION: Abracon LLC's products are COTS – Commercial-Off-The-Shelf products; suitable for Commercial, Industrial and, where designated, Automotive Applications. Abracon's products are not specifically designed for Military, Aviation, Aerospace, Life-dependent Medical applications or any application requiring high reliability where component failure could result in loss of life and/or property. For applications requiring high reliability and/or presenting an extreme operating environment, written consent and authorization from Abracon LLC is required. Please contact Abracon LLC for more information.