

NSJ

A New Single-package Concept

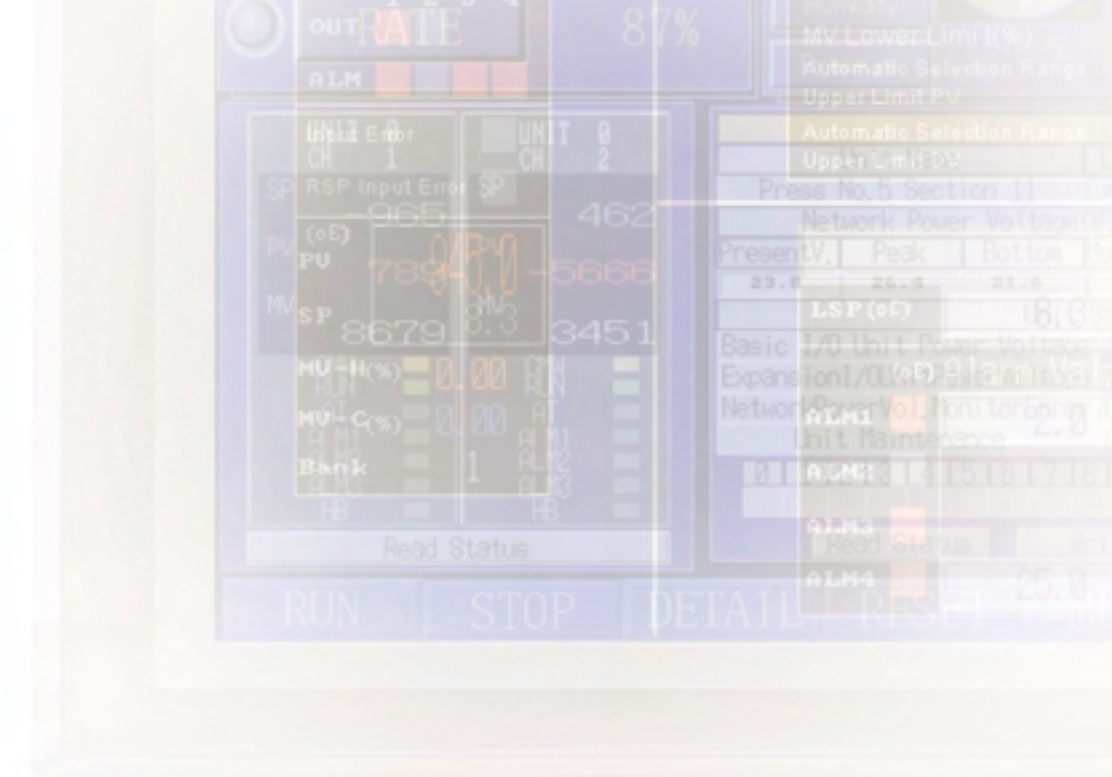

As demands continue to grow for smaller control panels to save space in today's production facilities, OMRON has shown the way with a unique solution -- the SYSMAC One NSJ-series One-package Controller. Its compact size is an ideal fit for the 400- to 500-mm control panel widths that are becoming increasingly common, and it completely eliminates the space that was previously necessary for the PLC. While helping to standardize control panels, the NSJ Series also solves a variety of manufacturing industry problems by raising the levels of efficiency in design and maintenance.

● Concept	4
● Product Line and Expandability	6
● Promoting Standardized Control Panels	8
● Less Effort in Designing and Debugging	10
● Less Effort in Maintenance	12
● Applications	14
● System Configuration	16
● Ordering Information and Specifications	19

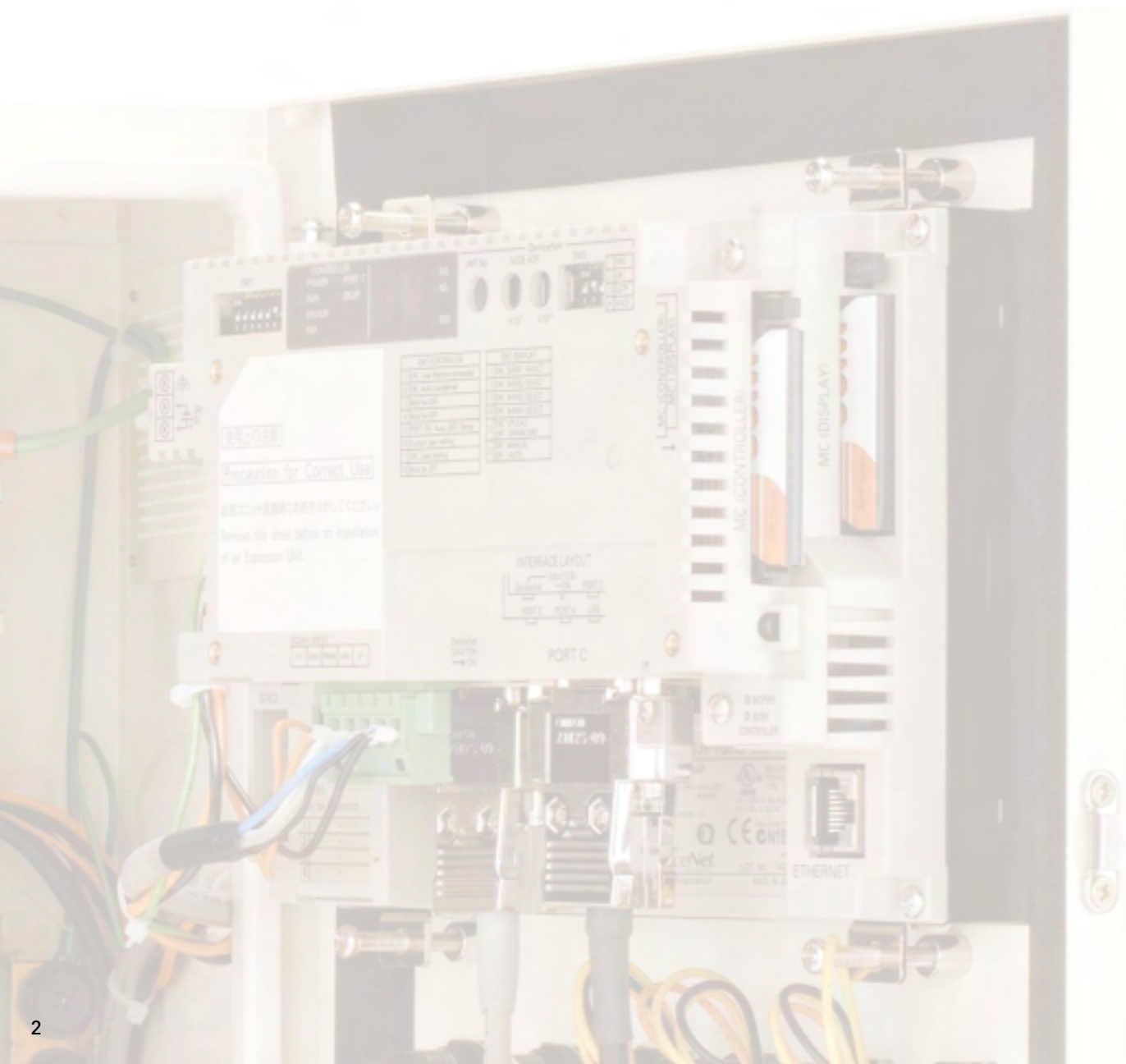

Greater Control Panel Downsizing and Standardizing

As production becomes increasingly globalized, the needs for standardized control panels are growing. With its new, one-package concept, the SYSMAC One NSJ Series contributes to reducing both hardware and software requirements for control panels. While offering the same convenient operation for control panels in any factory, any process, and any device worldwide, the NSJ Series eliminates various forms of inefficiency, waste, and inconsistency that extend all the way from device design and installation, to maintenance.

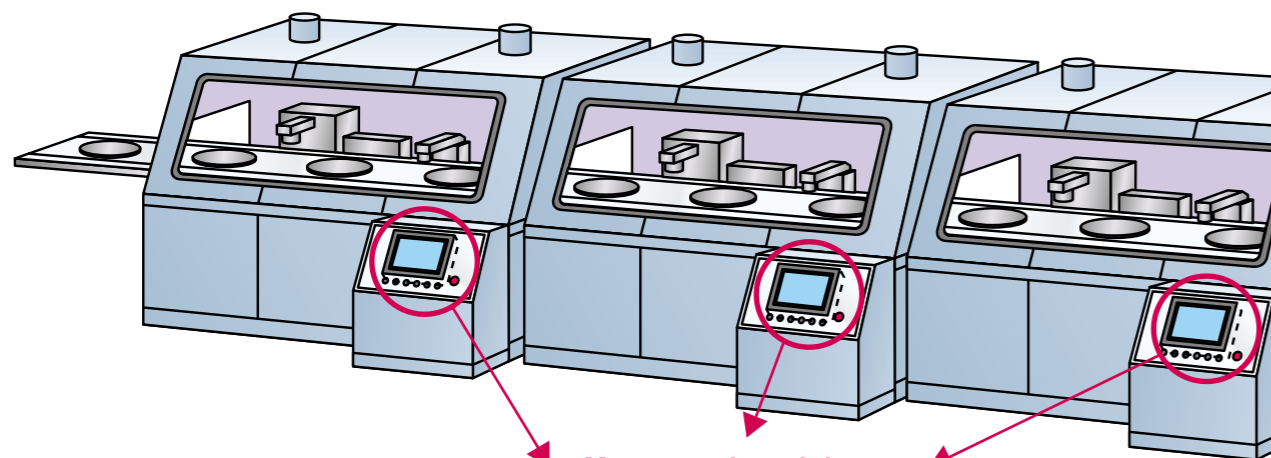

Many control panels have a width of 400 to 500 mm.

Today's manufacturing facilities are becoming increasingly space-efficient and standardized. The 400- to 500-mm panel width will likely become mainstream.



As an example, the SYSMAC One NSJ5 Series makes it possible to design a control panel this compact.

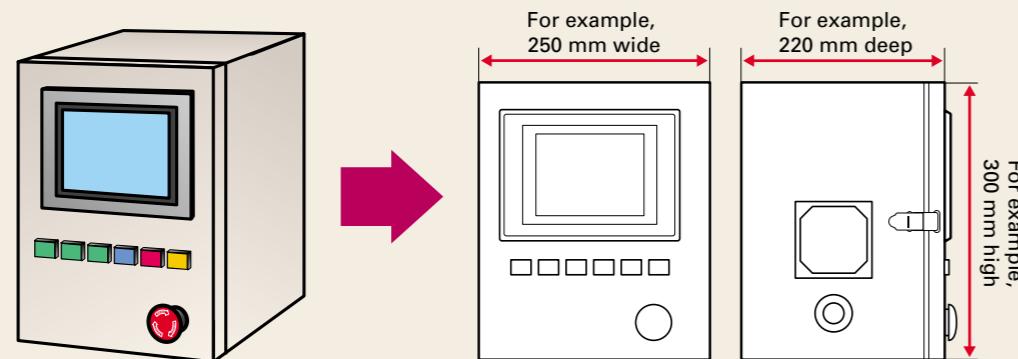

No More PLC Space Required.

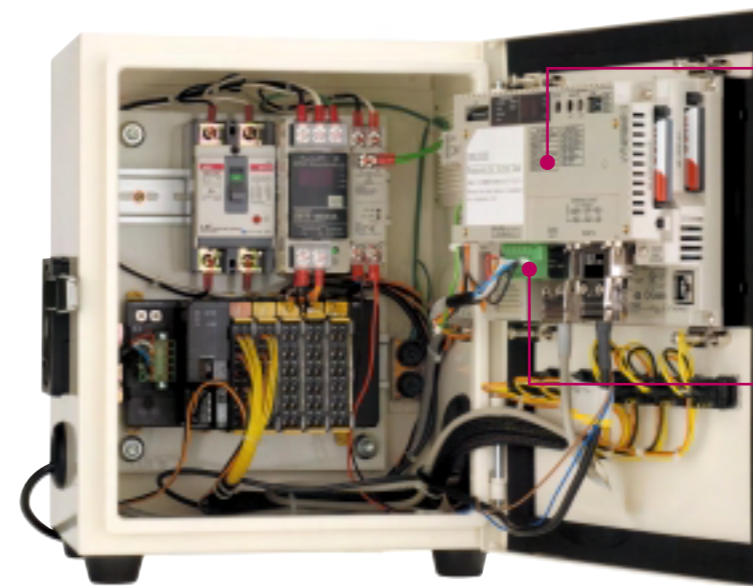

The PLC comes as standard equipment along with the HMI.

The Display Section and Controller Section each have a CPU. Control is highly reliable because it is not affected by the designing and communications of the Display Section.

A DeviceNet Master comes as standard equipment for I/O.

There is no need for initial settings, and wiring is greatly reduced. Also standardization and streamlining design can be realized.

Efficient use of the space inside the control panel.

Since there is no PLC space required, the space inside the control panel can be more efficiently used. For example, it can be used to mount the power supply, breakers, or terminal blocks directly behind the Display Section.

Especially slim at 73.3 mm.

Both the Display Section and Controller Section combined have a width of only 73.3 mm*. There is also no need for a PLC Power Supply Unit. (*For the NSJ8/10/12 Series. The NSJ5 Series is 79.0 mm.)

NSJ Series Appearance and Parts Names

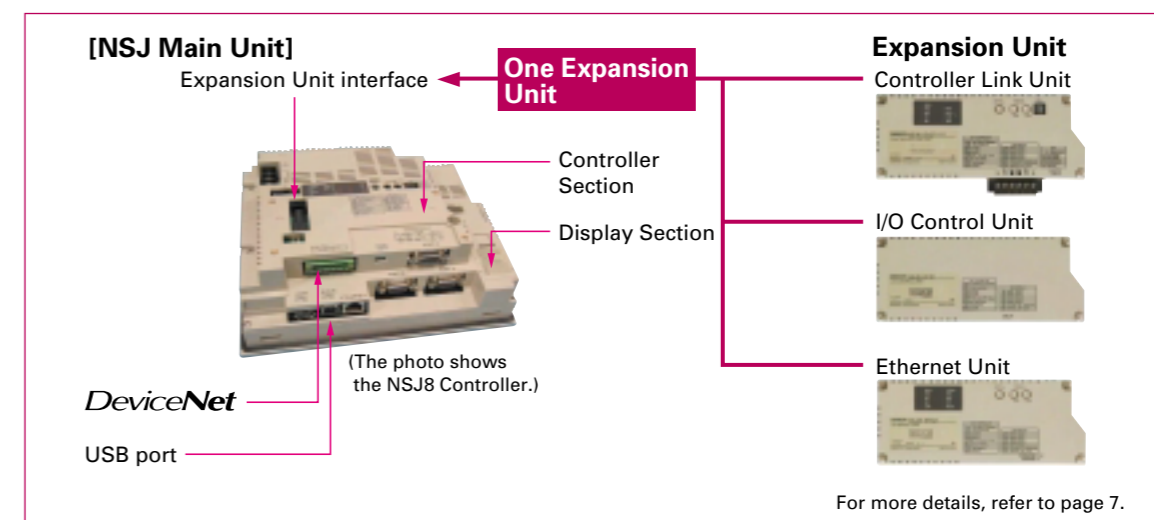
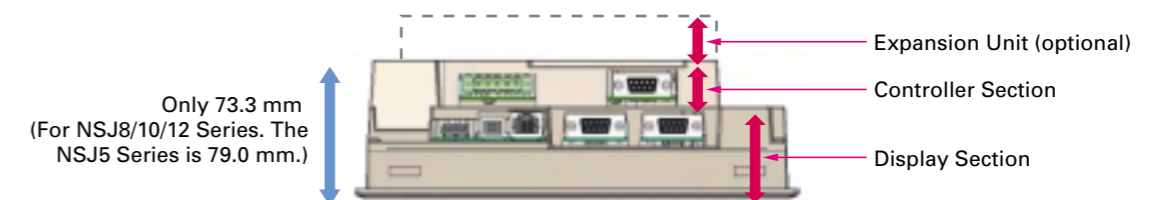

A Wide Selection of Scalable Display Controllers

Product Line-up Select the optimal control and display combination.

Four screen sizes are available, from 5.7 to 12.1 inches. The 5.7- and 8.4-inch models can be selected with different memory capacities and other functions to meet the needs of various scales of control.



		Display Section					Main Differences in Specifications
		5.7 Inches		8.4 Inches	10.4 Inches	12.1 Inches	
		Color TFT	Color High-luminance TFT				
Controller Section (Designated by model number suffix)	M3D	○	○	○	—	—	•I/O capacity: 640 •User memory: 20 Ksteps •Expanded data memory: None
	G5D	○	○	○	○	○	•I/O capacity: 1,280 •User memory: 60 Ksteps •Expanded data memory: 32 Kwords x 3 banks

Note: For more detailed specifications, refer to page 20.

NSJ Built-in Ethernet Port Easy access to both Display Section and Controller Section

Models are also available with Ethernet as a standard feature. This allows PLC data to be read or written without adding an Ethernet Unit. PLC data can also be read or written, and alarms and recipes can be transferred, from a host computer.

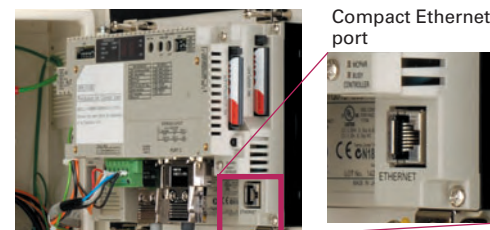

Easy Access from a Host Computer

- Screen data and ladder programs can be easily transferred via Ethernet.
- PLC data can also be read by a host application (using FINS communications).

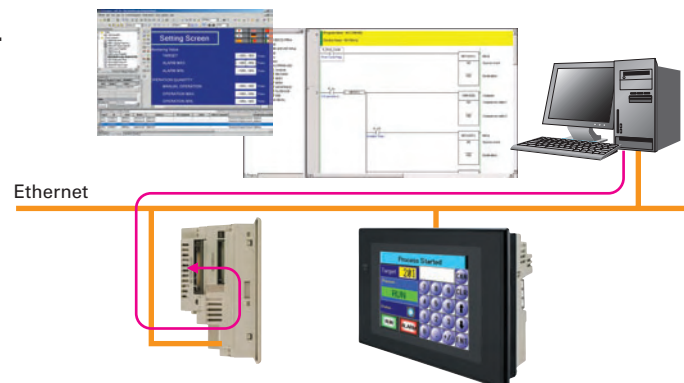

Easy Access to Other PLCs

- PLC2 data can be easily displayed and set from the NSJ (PLC1) display.

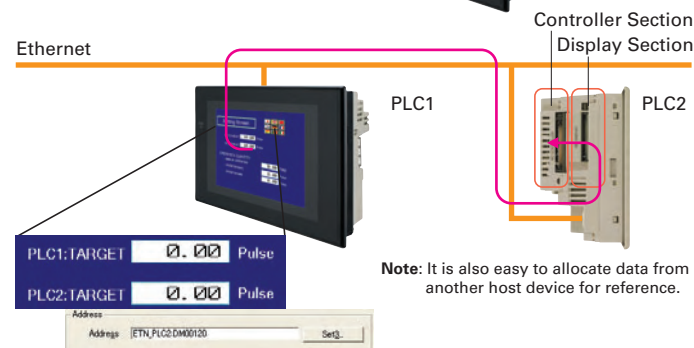

Expansion Units Support a wider range of applications.

Controller Link Unit (NSJW-CLK21-V1)

High-speed, large-capacity data link

The PLC data link function can be used to provide a high-speed, large-capacity data link between Controllers.



I/O Control Unit (NSJW-IC101)

Easy addition of Special I/O Units and CPU Bus Units

Used to mount Motion Control Units and other Special I/O Units or CPU Bus Units to the NSJ-series Controller, for excellent expandability.

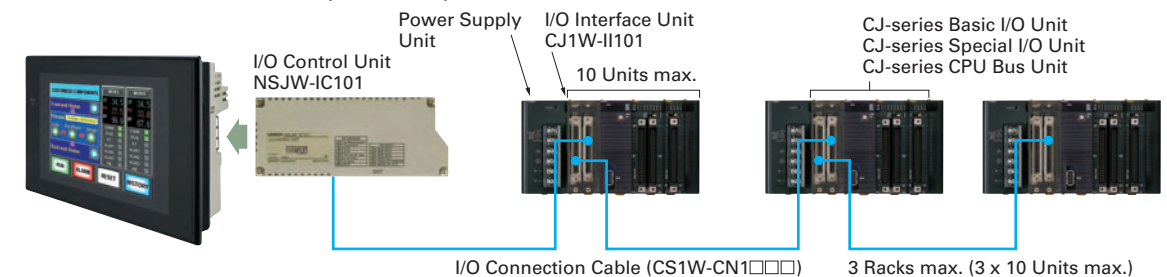

Note: Maximum of 3 Racks for models with model numbers with a suffix of -G5D, and 1 Rack for models with a suffix of -M3D.

Ethernet Unit (NSJW-ETN21)

Full use of versatile Ethernet functions

The NSJ built-in Ethernet port increases expandability with host computers by enabling functions such as communications implemented with CMND instructions and e-mail.

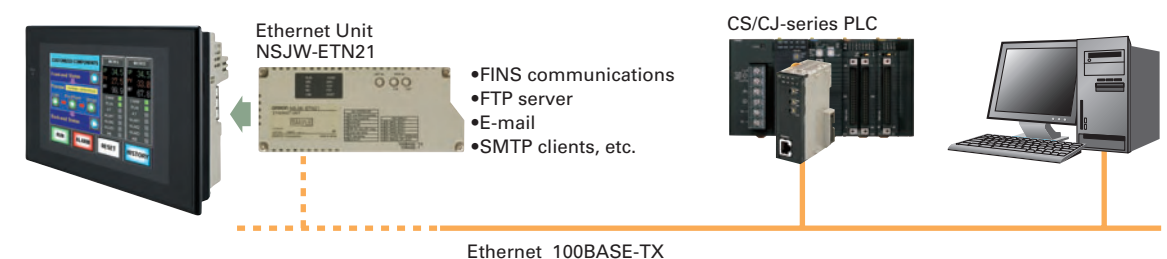

Note: For detailed information on functions related to the NSJ built-in Ethernet port and Ethernet Unit, refer to page 28.

Meeting the Growing Needs for Control Panel Standardization

The Market Is Moving Toward Standardized Control Panels.

With production bases becoming increasingly globalized, do you have the following concerns about shipping domestically manufactured devices?

- 1 Reduce downtime due to operator error
- 2 Providing on-site operator training
- 3 Smoothly procuring maintenance parts when a malfunction occurs
- 4 The need to raise development efficiency for devices and facilities

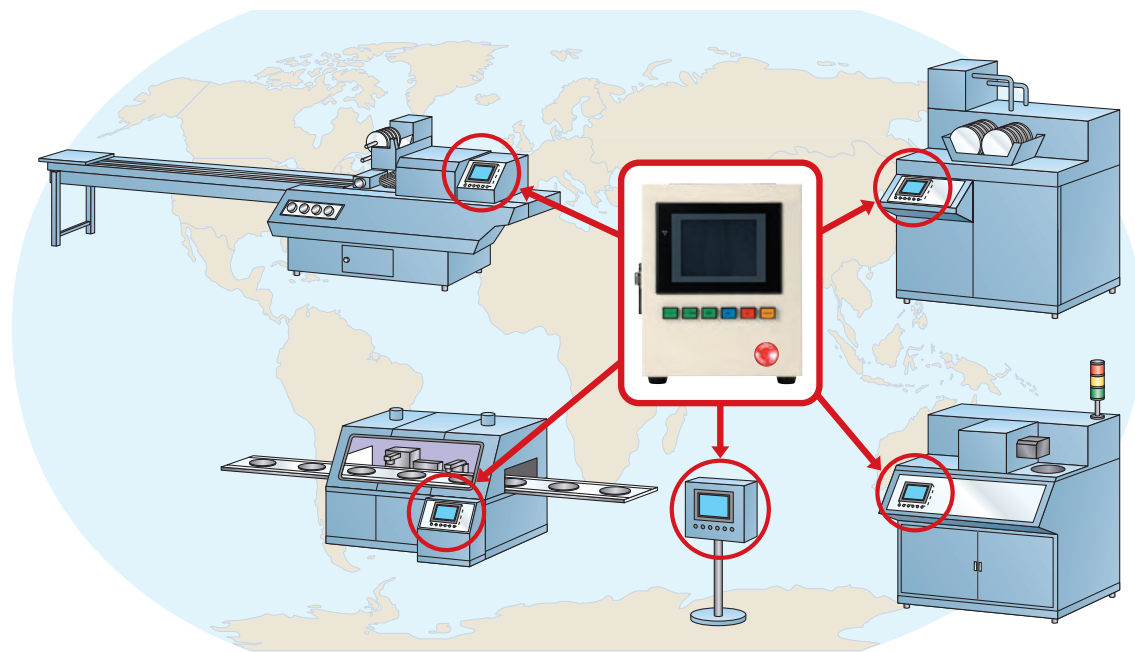

Effects of Standardizing Control Panels

Waste and inconsistency in design, installation and maintenance can be eliminated by supplying control panels that have the same basic operation regardless of the factory, the process, and the devices used in any country of the world.

- 1 Operating errors can be prevented by providing the same operability. Reduce temporary lower operating efficiency caused by changing operators.
- 2 There is no need to produce an operating manual for each device. Initial training cost can also be reduced.
- 3 Standardization greatly reduces the number of maintenance parts. Even if a malfunction occurs, the entire control panel can be replaced as a module for quick and easy system restoration.
- 4 Standardization makes it possible to create templates for design documents, screens, and ladder programs. This increases the ability to reuse the templates, which greatly raises design efficiency.

By standardizing control panels based on SYSMAC One, design steps can be reduced and software assets can be reused to eliminate waste and inconsistency all the way from the design stage to system startup.

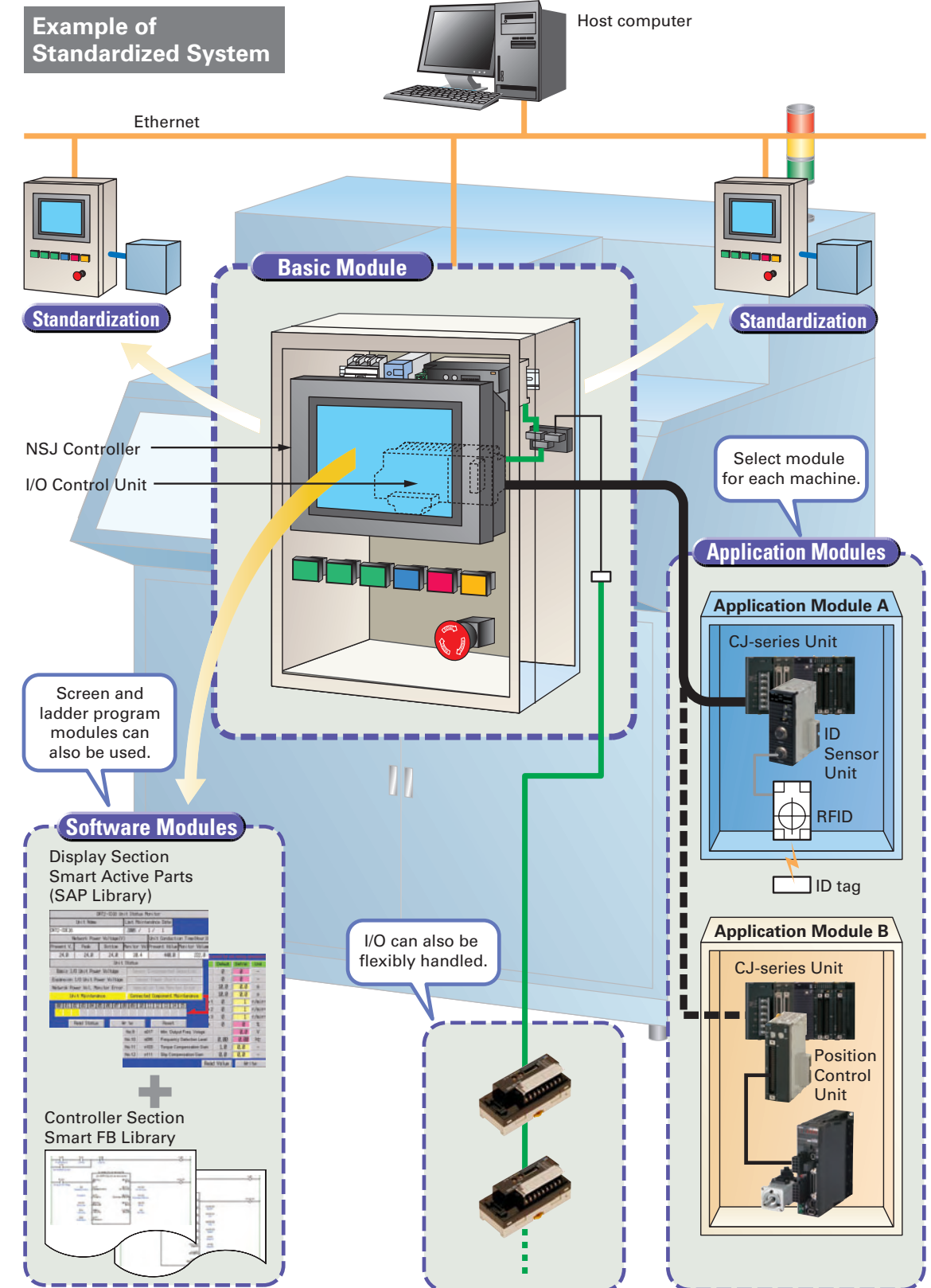

Advantages of One Package

Use of a single USB cable simplifies both design and debugging.

Use of a commercially available USB cable allows easy, high-speed transferring of screen data and ladder programs. There is also no need to change cables for transfers such as these.

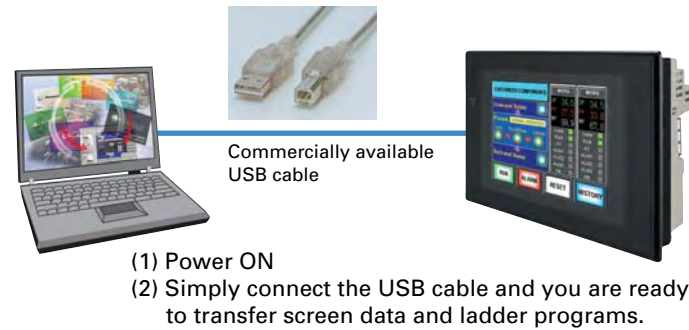

Continue using your software assets.

Continue to use all the screen data for NS-series PTs and ladder programs for CS/CJ-series PLCs.

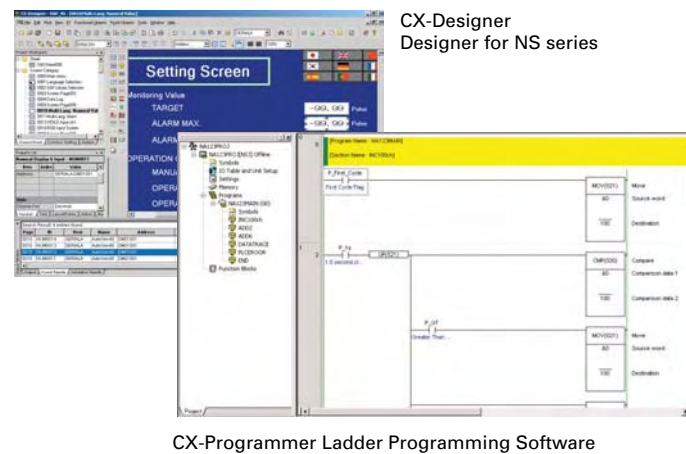

Simply turn ON the power and start using it. No need for initial settings.

There is no need to connect the Controller Section and Display Section, and no need to make initial communications settings or other settings.

The system starts up as soon as the power is turned ON. Even the standard-equipped DeviceNet Master is completely set in the default settings.

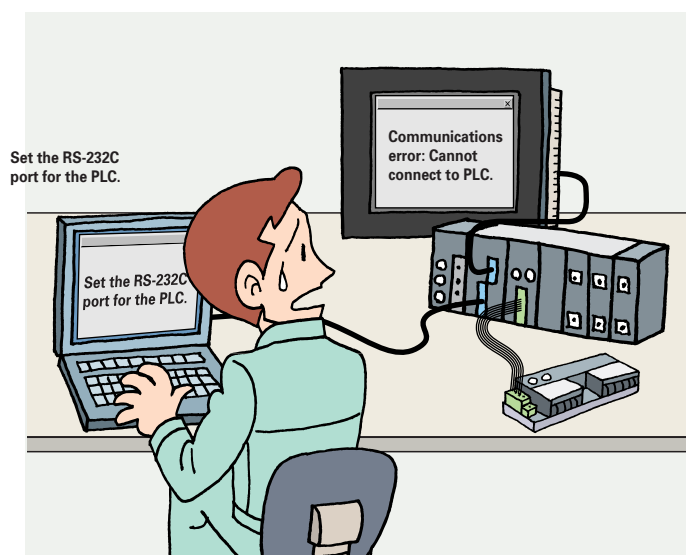

The CX-One Integrated FA Tool Package Is Available

This software can be used to debug ladder programs and screens without even having to connect to an actual system.

The test functions of the CX-Designer Screen Designer for NS Series have been further strengthened. By selecting CX-Simulator as the connection destination, screen data and ladder programs can be simultaneously tested without even having to connect to an actual system.

Integrated Simulation

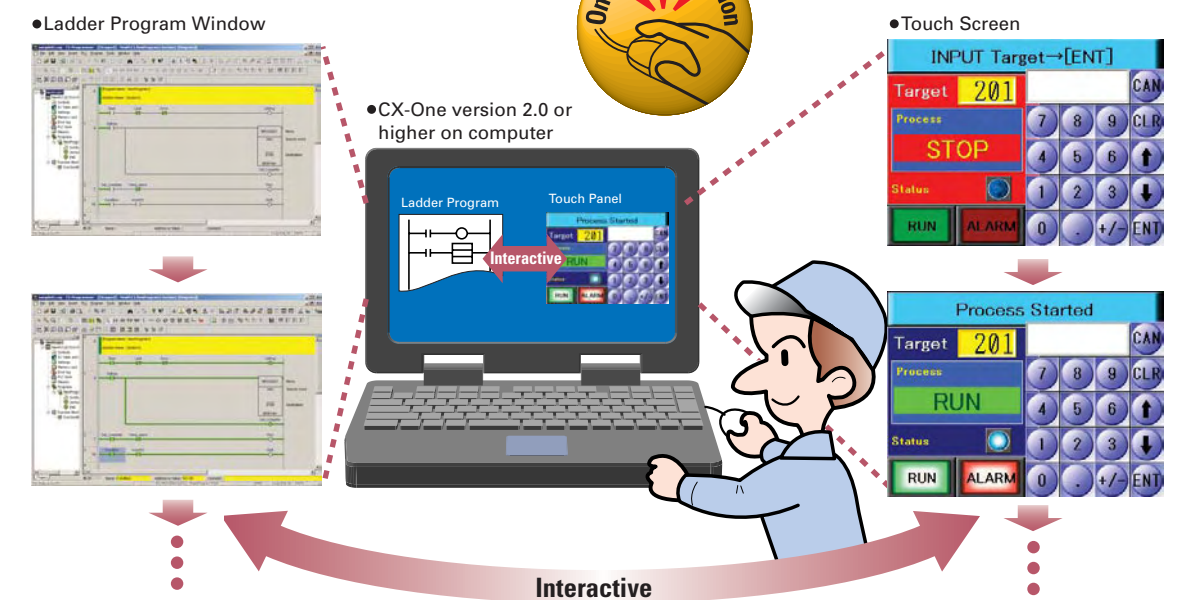

The SAP Library, which dramatically reduces effort in design, has also been greatly expanded.

More than 2,000 Smart Active Parts (SAP) are available for directly accessing OMRON PLCs and components. Simply copy them from the library and paste them onto the screen. There is absolutely no need to design screens or ladder programs for these objects.

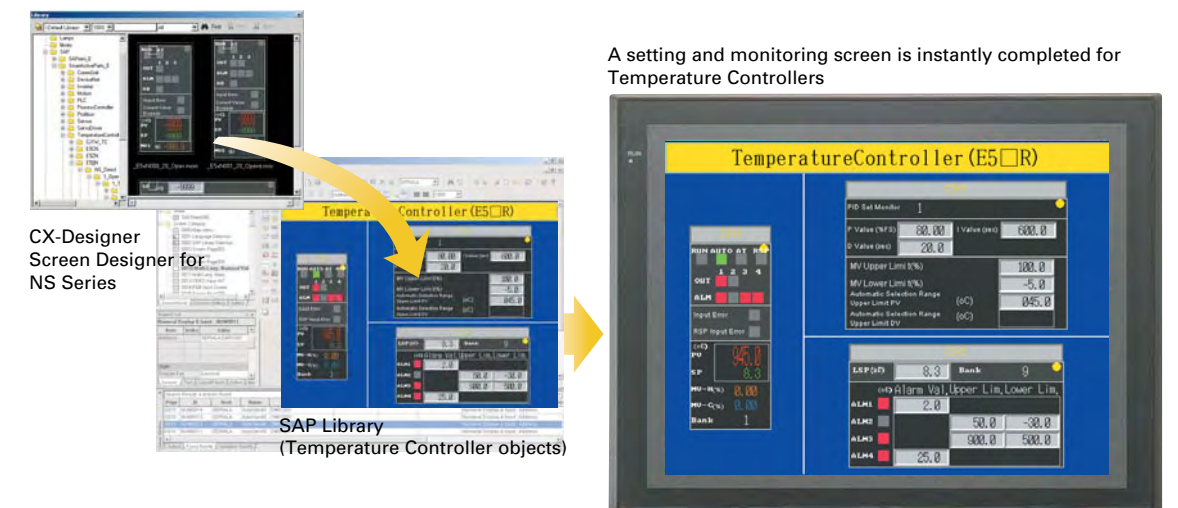

Two Troubleshooters Come as a Standard Feature

Enables a quick, on-site action without any software.

The standard-equipped PLC Troubleshooter and DeviceNet Troubleshooter contribute to solving problems during device startup and operation. When an error occurs, simply follow the on-screen instructions to confirm the error details and quickly implement countermeasures, without referring to the manual.

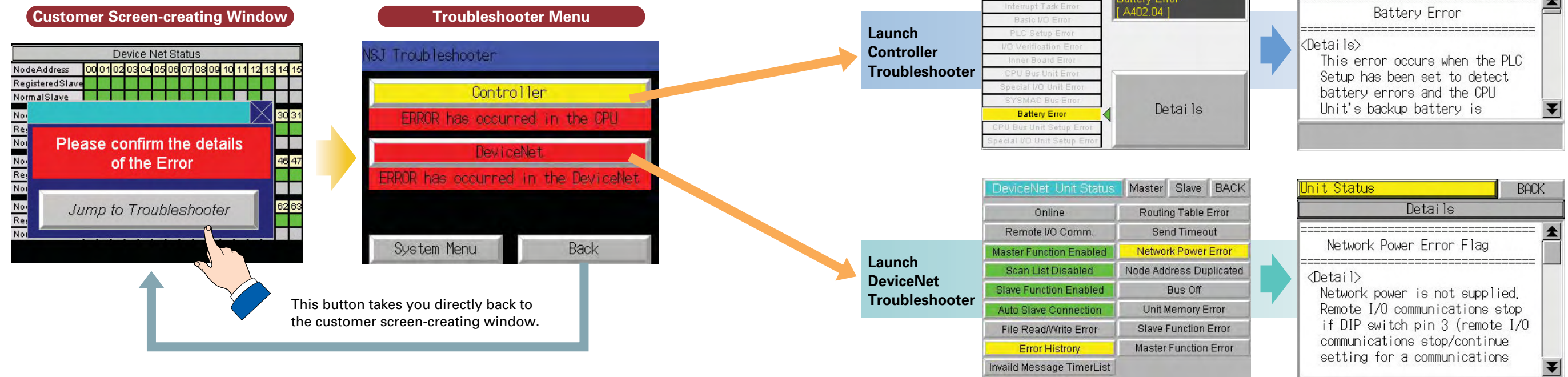

A Ladder Program Monitor Is Also Standard

Switching from the operation screen to the screen for monitoring PLC ladder programs only takes about 5 seconds.

This software lets you monitor PLC program status, search for addresses or instructions, monitor multiple I/O points, and much more. It only takes about 5 seconds to switch from a user screen to the ladder program monitoring screen. From a selected input bit, you can also search for the next sequence output instruction that uses the same address.

The PLC ladder program is displayed in about 5 s.

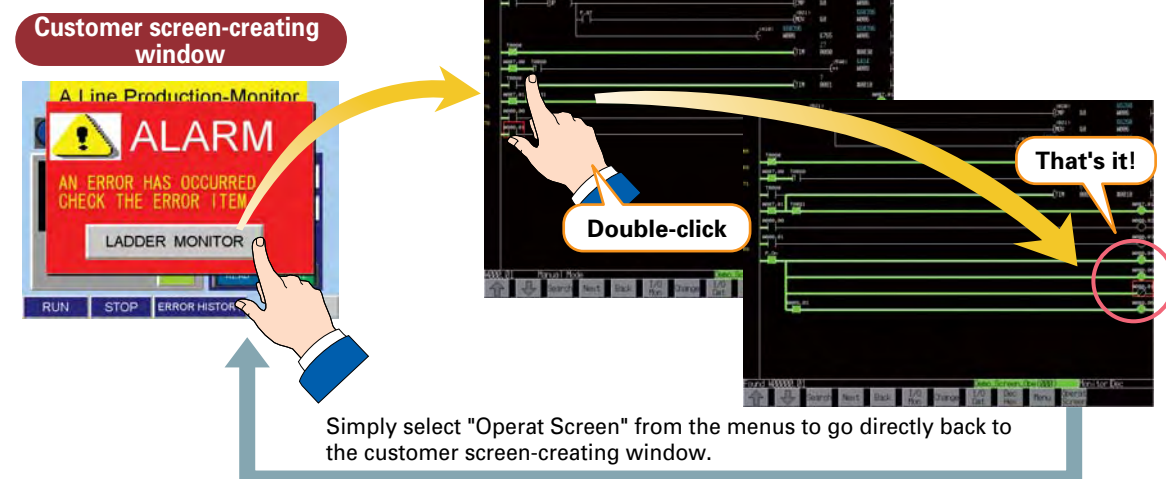

A Data Backup Function Is Also Standard

Easy backup without a computer.

Simply follow the on-screen instructions to back up both screen data and ladder programs for the Controller Section.

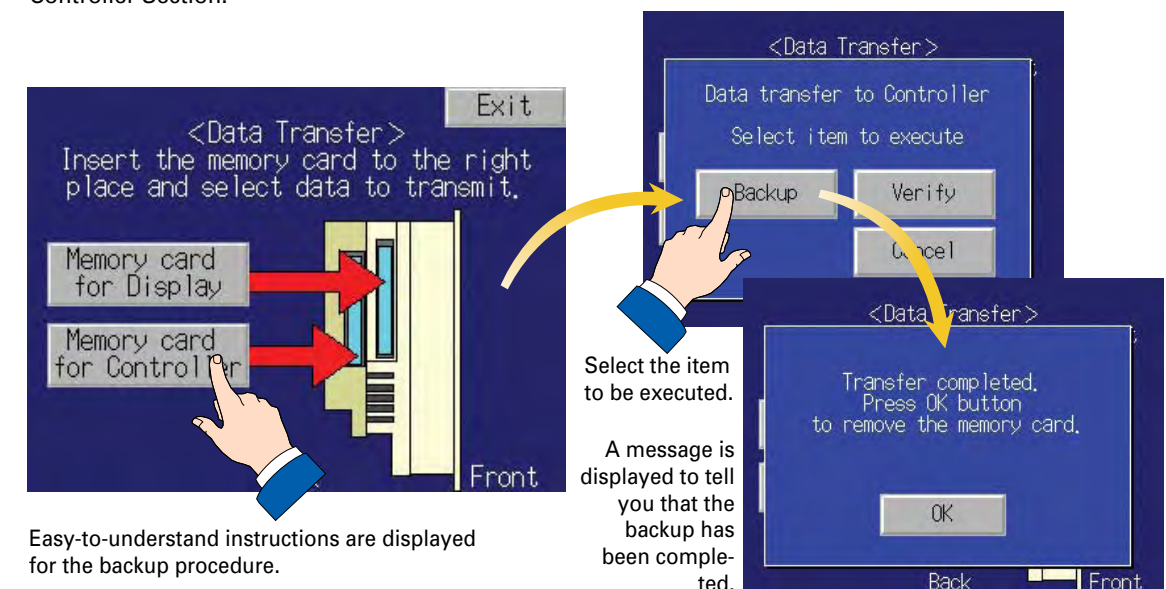

Production control system

Production control information is given by the host computer concerning production progress, retooling instructions, alarms, etc.

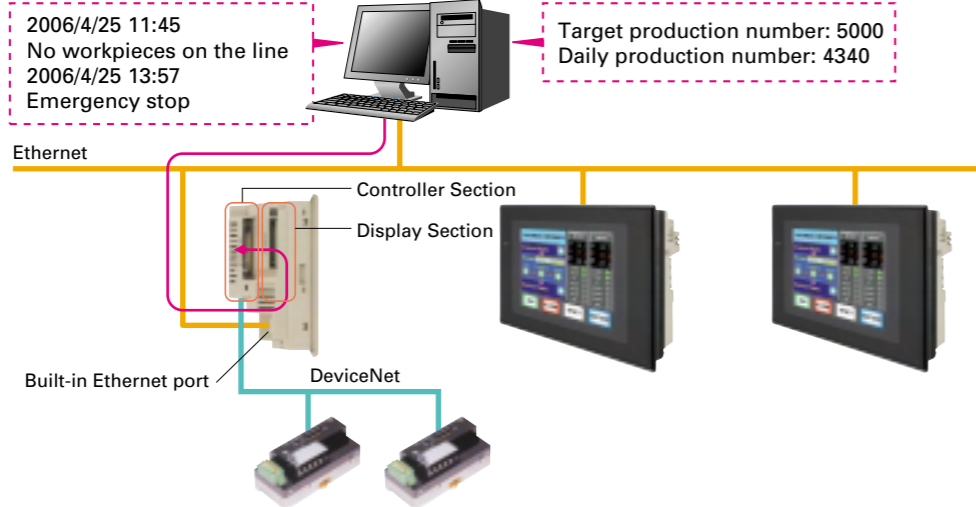

[NSJ Series Advantages]

- Both the Display Section and Controller Section can be accessed through a single Ethernet port.
- Information for the Controller Section and Display Section (such as alarms) can be received at a host computer.
- There is no need to make initial settings for the Display Section or Controller Section.
- Using the built-in Ethernet port eliminates the need for an Expansion Unit.

POP system

Products are controlled by a bar code reader. Information is uploaded to a host computer for product information management.

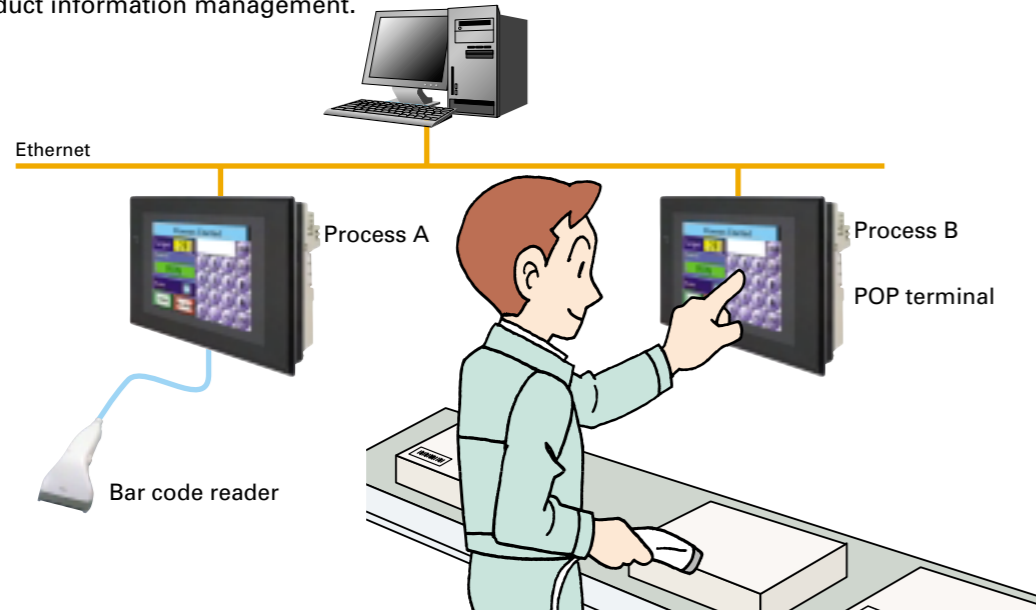

[NSJ Series Advantages]

- The terminal can be installed anywhere since it saves space.
- Connection with the host can be made using the built-in Ethernet port.

Simple positioning control

Simple positioning control can be achieved by connecting the NSJ to a robot controller.

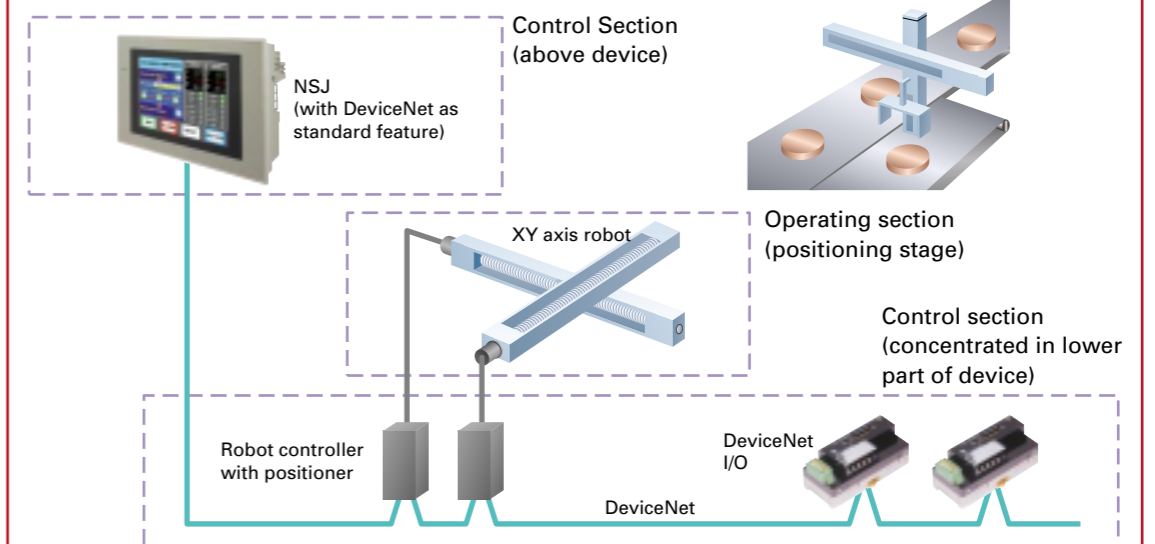

[NSJ Series Advantages]

- Simple positioning control can be achieved with minimal wiring by directly connecting the NSJ to a robot controller.
- I/O can also be directly connected to reduce wiring.
- There is no more need for PLC space in the bottom of the control panel.

DeviceNet monitoring

The smart functions of various slaves connected to DeviceNet can be monitored.

Example: By using a Slave Unit to count the number of ON/OFF operations for a device, or to count the total operating hours, the NSJ can inform the operator when it is time to conduct maintenance.

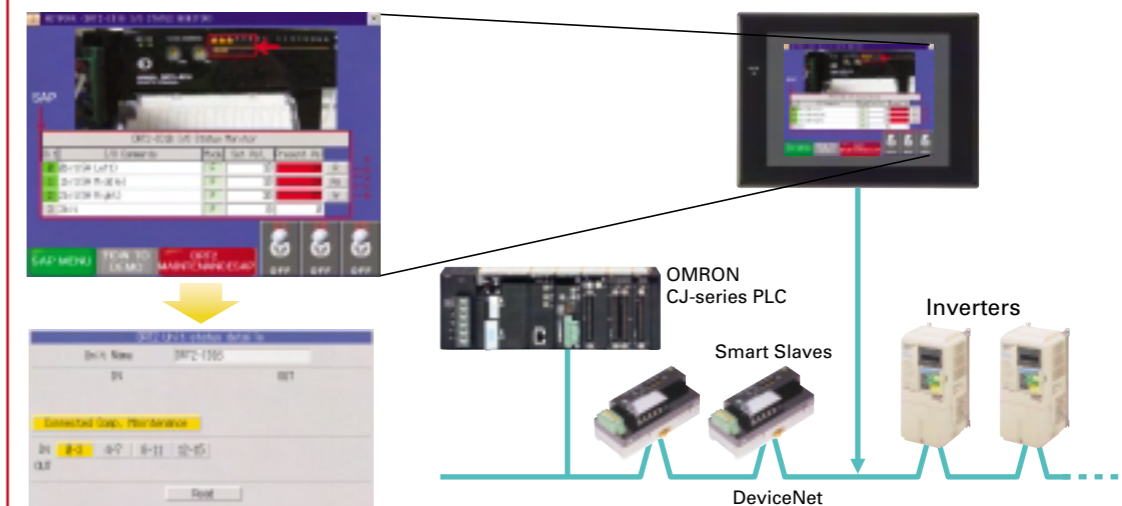

[NSJ Series Advantages]

- Monitoring and diagnostic functions can be added to the control panel.
- Wiring and space requirements are reduced, and the NSJ can be added on later.
- The number of design steps can be reduced for screen design and ladder programming by using the Smart Active Parts (SAP) Library and troubleshooter functions.

Suitable to a Wide Range of Applications

System Configuration

A variety of networks can be easily constructed using the standard-equipped DeviceNet, USB, Ethernet, and RS-232C interfaces. This increases the types of equipment that can be connected to the NSJ Series in addition to the wide line-up of highly compatible OMRON control components, and provides a level of expandability that meets virtually all application needs.

- Combined use (the Display Section and Controller Section can be accessed from a single port)
- Controller Section (for use with ladder programs, etc.)
- Display Section (for directly uploading graphs or making settings)

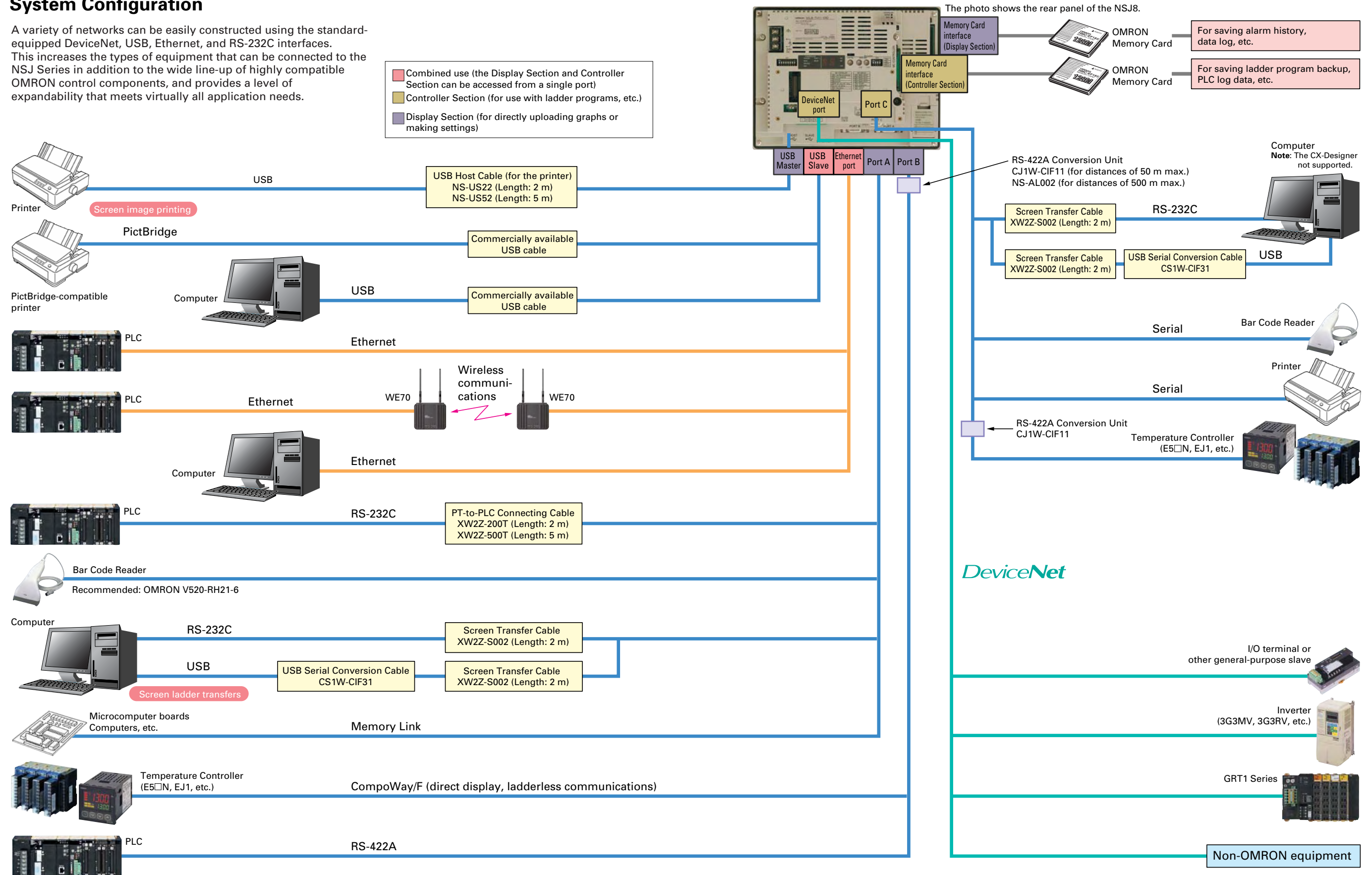

Concept

Product Line and Expandability

Promoting Standardized Control Panels

Less Effort in Designing and Debugging

Less Effort in Maintenance

Applications

System Configuration

Ordering Information and Specifications

Ordering Information and Specifications

Standard Models	20
■ Controllers.....	20
■ Options and Expansion Units.....	21
● Differences between the NSJ□-□□□□-G5D and NSJ□-□□□□-M3D	21
General Specifications.....	22
■ NSJ Controllers.....	22
■ NSJ Expansion Units	22
Controller Section Specifications.....	23
Display Section Specifications.....	26
Communications Section Specifications.....	27
■ DeviceNet Section	27
■ Controller Link (Wired).....	27
■ Ethernet Unit.....	28
■ Differences between the Built-in Ethernet and Ethernet Unit Ports	28
Support Software.....	29
■ Ordering Information.....	29
Dimensions.....	30

●International Standards

- The standards are abbreviated as follows: U: UL, U1: UL (Class I Division 2 Products for Hazardous Locations), C: CSA, UC: cULus, UC1: cULus (Class I Division 2 Products for Hazardous Locations), CU: cUL, N: NK, L: Lloyd, and CE: EC Directives.
- Contact your OMRON representative for further details and applicable conditions for these standards.

●EC Directives

The EC Directives applicable to PLCs include the EMC Directives. OMRON complies with these directives as described below.

●EMC Directives

Applicable Standards EMI: EN61131-2
 EN61000-6-4
 EMS: EN61131-2
 EN61000-6-2

PLCs are electrical devices that are incorporated in machines and manufacturing installations. OMRON PLCs conform to the related EMC standards so that the devices and machines into which they are built can more easily conform to EMC standards. The actual PLCs have been checked to ensure conformity to EMC standards. Whether these standards are satisfied for the actual system, however, must be checked by the customer.

EMS-related performance will vary depending on the configuration, wiring, and other conditions of the equipment or control panel in which the PLC is installed. The customer must, therefore, perform final checks to confirm that the overall machine or device conforms to EMC standards.

Note: The applicable EMS standards depend on the product.

Standard Models

■ Controllers

NSJ□-□□□□-M3D

Name	Controller Section							Display Section				Built-in Ethernet port	Model number	Standards			
	I/O	User program memory	Data memory	Extended data memory	LD instruction execution time	Number of Expansion Racks	FB program memory (bytes)	Display device	Case color	Effective display area	Resolution						
SYSMAC One NSJ-series NSJ Controller	640 points	20 Ksteps	32 Kwords (DM: 32 Kwords)	EM: None	0.04 μs	1	256 KB	5.7-inch color TFT LCD	Ivory	117.2 × 88.4 mm (W × H) (5.7 inches)	320 × 240 (QVGA)	No	NSJ5-SQ10-M3D	UC1, CE UL Type4			
									Black								
									Ivory								
									Black								
								5.7-inch color High-luminance TFT LCD (See note 2.)	Ivory			No	NSJ5-TQ10-M3D				
									Black								
									Ivory								
									Black								
								8.4-inch color TFT LCD	Ivory	170.9 × 128.2 mm (W × H) (8.4 inches)	640 × 480 (VGA)	No	NSJ8-TV00-M3D				
									Black								
									Ivory								
									Black								
														Yes	NSJ8-TV01-M3D	UC1, CE	

Note 1. From February 2010, the image memory has been increased to 60 MB.

Now, even the 5.7-inch class models have 60 MB of screen data capacity as a standard feature and also enhanced main memory.

Existing screen data for the NSJ5-□Q□(B)-M3D/-G5D can be reused without any conversion.

Note 2. NSJ5-TQ series (high luminance TFT) luminance is better than that of NSJ5-SQ series by about 110cd/m².

NSJ□-□□□□-G5D

Name	Controller Section							Display Section				Built-in Ethernet port	Model number	Standards												
	I/O	User program memory	Data memory	Extended data memory	LD instruction execution time	Number of Expansion Racks	FB program memory (bytes)	Display device	Case color	Effective display area	Resolution															
SYSMAC One NSJ-series NSJ Controller	1280 points	60 Ksteps	128 Kwords (DM: 32 Kwords)	EM: 32 Kwords × 3 banks	0.04 μs	3	1024 KB	5.7-inch color TFT LCD	Ivory	117.2 × 88.4 mm (W × H) (5.7 inches)	320 × 240 (QVGA)	No	NSJ5-SQ10-G5D	UC1, CE UL Type4												
									Black																	
									Ivory																	
									Black																	
								5.7-inch color High-luminance TFT LCD (See note 2.)	Ivory			No	NSJ5-TQ10-G5D													
									Black																	
									Ivory																	
									Black																	
								8.4-inch color TFT LCD	Ivory	170.9 × 128.2 mm (W × H) (8.4 inches)	640 × 480 (VGA)	No	NSJ8-TV00-G5D													
									Black																	
									Ivory																	
									Black																	
																							Yes	NSJ8-TV01-G5D	UC1, CE	
								10.4-inch color TFT LCD	Ivory	215.2 × 162.4 mm (W × H) (10.4 inches)	640 × 480 (VGA)	No	NSJ10-TV00-G5D													
									Black																	
									Ivory																	
									Black																	
														Yes	NSJ10-TV01-G5D	UC1, CE UL Type4										
12.1-inch color TFT LCD	Ivory	246.0 × 184.5 mm (W × H) (12.1 inches)	800 × 600 (SVGA)	No	NSJ12-TS00-G5D																					
	Black																									
	Ivory																									
	Black																									
														Yes	NSJ12-TS01-G5D	UC1, CE UL Type4										

Note 1. From February 2010, the image memory has been increased to 60 MB.

Now, even the 5.7-inch class models have 60 MB of screen data capacity as a standard feature and also enhanced main memory.

Existing screen data for the NSJ5-□Q□(B)-M3D/-G5D can be reused without any conversion.

Note 2. NSJ5-TQ series (high luminance TFT) luminance is better than that of NSJ5-SQ series by about 110cd/m².

Options and Expansion Units

Name		Specifications	Model	Standards
Expansion Units	NSJ Controller Link Unit	For increasing the number of Controller Link ports Same as the CJ1W-CLK21-V1 Controller Link Unit for the CJ Series.	NSJW-CLK21-V1	UC1, CE
	NSJ Ethernet Unit	For increasing the number of Ethernet ports Same as the CJ1W-ETN21 Ethernet Unit for the CJ Series.	NSJW-ETN21	
	NSJ I/O Control Unit	For adding CJ-series Expansion Racks. Same as the CJ1W-IC101 I/O Control Unit for the CJ Series. Use the following I/O Connecting Cables.	NSJW-IC101	
I/O Connecting Cables	For connecting CJ-series Expansion Racks.	0.3 m	CS1W-CN313	N, L, CE
		0.7 m	CS1W-CN713	
		2 m	CS1W-CN223	
		3 m	CS1W-CN323	
		5 m	CS1W-CN523	
		10 m	CS1W-CN133	
		12 m	CS1W-CN133-B2	
Memory Cards (for both Controller Section and Display Section)	Flash memory: 128 MB		HMC-EF183	N, L, CE
	Flash memory: 256 MB		HMC-EF283	
	Flash memory: 512 MB		HMC-EF583	
	Memory Card Adapter (for computer PCMCIA slot)		HMC-AP001	CE
Peripheral Device Connecting Cables for the RS-232C port	Connects computer, D-Sub 9-pin, Length: 2.0 m	Used for peripheral bus or Host Link. Anti-static connectors	XW2Z-200S-CV	---
	Connects computer, D-Sub 9-pin, Length: 5.0 m		XW2Z-500S-CV	
	Connects computer, D-Sub 9-pin, Length: 2.0 m	Used for Host Link only. Peripheral bus not supported.	XW2Z-200S-V	
	Connects computer, D-Sub 9-pin, Length: 5.0 m		XW2Z-500S-V	
RS-422A Conversion Adapter	Adapter for converting a RS-232C port to a RS-422A/485 port.	Communications distance: 500 m max.	NS-AL002	---
		Communications distance: 50 m max.	CJ1W-CIF11	
Battery life	5 years at 25°C		CJ1W-BAT01	CE

● Differences between the NSJ□-□□□□-G5D and NSJ□-□□□□-M3D

Function	Model	NSJ□-□□□□-G5D	NSJ□-□□□□-M3D
UM capacity		60 Ksteps	20 Ksteps
I/O		1,280 points	640 points
Extended data memory		32 Kwords × 3 banks	None
EM file memory		Yes	None
Maximum number of Expansion Racks		3	1
FB program memory capacity		1024 KB	256 KB
Maximum number of FB definitions		1,024	128
Maximum number of FB instances		2,048	256
Variable table size		128 KB	64 KB

General Specifications

Parts Names

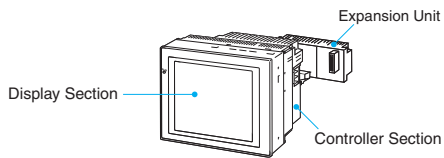

■NSJ Controllers

Model	Specifications			
	NSJ12-TS0□-G5D	NSJ10-TV0□-G5D	NSJ8-TV0□-G5D NSJ8-TV0□-M3D	NSJ5-TQ1□-G5D NSJ5-SQ1□-G5D NSJ5-TQ1□-M3D NSJ5-SQ1□-M3D
Items				
Supply voltage	24 VDC			
Allowable supply voltage range	20.4 to 27.6 VDC (24 VDC ±15%)			
Power consumption	30 W max.			SQ1□: 21 W max. TQ1□: 22 W max.
Current consumption	Controller Section Internal 5 V: 500 mA max. DeviceNet Section Internal 5 V: 200 mA max., External 24 V: 18 mA max.			
Inrush current (See note 1.)	At 24 VAC: 10 A/20 ms max. for cold start at room temperature			
Ambient operating temperature (depending on angle of display surface off horizontal) (See note 2.)	90° to 60°: 0 to 50°C 60° to 30°: 0 to 45°C 30° to 0°: Use prohibited.			90° to 30°: 0 to 50°C 30° to 0°: 0 to 40°C
Ambient storage temperature	-20 to 60°C			
Ambient operating humidity	0 to 40°C: 35% to 85% (with no condensation) 40 to 50°C: 35% to 60% (with no condensation)			
Ambient operating environment	No corrosive gases			
Insulation resistance	20 MΩ min. (at 100 VDC) between DC external and GR terminals			
Dielectric strength	800 VDC for 1 min between DC external and GR terminals, leakage current: 10 mA max.			
Noise immunity	2 kV on power supply line (conforming to IEC 61000-4-4)			
Vibration resistance (during operation)	10 to 57 Hz, 0.075-mm amplitude, 57 to 150 Hz, acceleration: 9.8 m/s ² in X, Y, and Z directions for 80 minutes			
Shock resistance (during operation)	147 m/s ² , 3 times each in X, Y, and Z directions			
External dimensions (See note 3.)	Without Expansion Unit	315 × 241 × 73.3 mm (W × H × D)	232 × 177 × 73.3 mm (W × H × D)	195 × 142 × 79 mm (W × H × D)
	With Expansion Unit	315 × 241 × 89.3 mm (W × H × D)	232 × 177 × 89.3 mm (W × H × D)	195 × 142 × 95 mm (W × H × D)
Panel cutout dimensions	302 ⁺¹ ₀ × 228 ⁺¹ ₀ mm (W × H) Panel thickness: 1.6 to 4.8 mm		220.5 ^{+0.50} ₀ × 165.5 ^{+0.50} ₀ mm (W × H) Panel thickness: 1.6 to 4.8 mm	184 ^{+0.50} ₀ × 131 ^{+0.5} ₀ mm (W × H) Panel thickness: 1.6 to 4.8 mm
Grounding	100 Ω or less			
Weight	2.7 kg max.	2.5 kg max.	2.0 kg max.	1.1 kg max.
Degree of protection	Front operating panel: Equivalent to IP65 Oil-proof type and NEMA4 (See note 4.)			Front operating panel: Equivalent to IP65 Oil-proof type, NEMA4 and UL Type 4 (See note 4.)
Battery life	5 years (at 25°C) The SRAM and RTC will be backed up for 5 days after the battery runs low (i.e., after the indicator lights orange). The SRAM and RTC will be backed up by a super capacitor for 5 minutes after removing the old battery (i.e., after turning ON power after 5 minutes).			
International standards	Conforms to cULus and EC Directives.			

Note 1. A delay circuit that charges a capacitor is used to limit the inrush current. If a hot start is performed when the power supply has been OFF only a short period of time, the capacitor will still be charged and the inrush current specified above will be exceeded by up to approximately five times the specified value.

When selecting fuses or breakers for external circuits, allow sufficient margin in the melting temperatures, detection characteristics, and inrush current

Note 2. Display angles off horizontal are as follows:

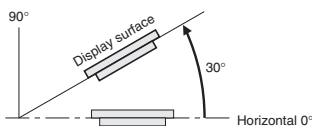

Note 3. For detailed information, refer to "Dimensions" on page 30.

Note 4. May not be applicable in locations with long-term exposure to oil.

■NSJ Expansion Units

Controller Link Unit

Item	Specifications
Model	NSJW-CLK21-V1
Current consumption	300 mA
Weight	100 g max.

Note: Other general specifications are the same as the NSJ Controller.

I/O Control Unit

Item	Specifications
Model	NSJW-IC101
Current consumption	20 mA
Weight	100g max.

Note: Other general specifications are the same as the NSJ Controller.

Ethernet Unit

Item	Specifications
Model	NSJW-ETN21
Current consumption	370 mA
Weight	100 g max.

Note: Other general specifications are the same as the NSJ Controller.

Controller Section Specifications

Item		Specifications
Control method		Stored program
I/O control method		Cyclic scan and immediate processing are both possible.
Programming		Ladder diagram
CPU processing modes		Normal Mode, Parallel Processing Mode with Asynchronous Memory Access, Parallel Processing Mode with Synchronous Memory Access, and Peripheral Servicing Priority Mode
Instruction length		1 to 7 steps per instruction
Ladder instructions		Approx. 400 (3-digit function codes)
Execution time	Basic instructions	0.04 µs min.
	Special instructions	0.06 µs min.
Overhead time		Normal mode: 0.3 ms Parallel processing: 0.3 ms
Installation		Installed using Panel Mounting Bracket.
Mountable Expansion Units		One of the following can be mounted as an Expansion Unit: <ul style="list-style-type: none"> • NSJ I/O Control Unit (NSJW-IC101) • NSJ Controller Link Unit (NSJW-CLK21-V1) • NSJ Ethernet Unit (NSJW-ETN21)
Maximum number of Expansion Racks		<ul style="list-style-type: none"> • With the NSJW-IC101 I/O Control Unit mounted, a maximum of three CJ-series Expansion Racks can be used with the NSJ□-□□□□(B)-G5D, and a maximum of one CJ-series Expansion Rack can be used with the NSJ□-□□□□(B)-M3D. • A CJ-series CJ1W-II101 Interface Unit and Power Supply Unit are required for each Expansion Rack.
Maximum number of connectable Units		<ul style="list-style-type: none"> • Per Expansion Rack: 10 Units max. (Basic I/O Units, Special I/O Units, or CPU Bus Units) • A maximum of 30 Units (10 Units on CJ-series Expansion Rack × 3) can be mounted to the entire NSJ□-□□□□(B)-G5D system. A maximum of 10 Units (10 Units on CJ-series Expansion Rack × 1) can be mounted to the entire NSJ□-□□□□(B)-M3D system.
Number of tasks		288 (cyclic tasks: 32, interrupt tasks: 256) Interrupt tasks can be defined as cyclic tasks called "extra cyclic tasks." Including these, up to 288 cyclic tasks can be used. Note 1. Cyclic tasks are executed each cycle and are controlled with TKON(820) and TKOF(821) instructions. Note 2. The following 3 types of interrupt tasks are supported: Power OFF interrupt task: 1 max., Scheduled interrupt tasks: 2 max., External interrupt tasks: 256 max.
Interrupt types		Scheduled Interrupts: Interrupts generated at a time scheduled by the Controller Section's built-in timer. (See note. 1) Power OFF Interrupt (See note 2.): Interrupt executed when the Controller Section's power is turned OFF. External I/O Interrupts: Interrupts from the Special I/O Units or CPU Bus Units. Note 1. Scheduled interrupt time interval is either 1 ms to 9,999 ms or 10 ms to 99,990 ms, in units of 1 ms or 10 ms. Note 2. Not supported when the CJ1W-PD022 Power Supply Unit is mounted.
Calling subroutines from more than one task		Supported using global subroutines.
Function blocks		Languages supported in function block definitions: Ladder programming language and structured text
CIO (Core I/O) Area	I/O Area	2,560 (160 words): CIO 00000 to CIO 015915 (words CIO 0000 to CIO 0159) The setting of the first rack word can be changed from the default (CIO 0000) so that CIO 0000 to CIO 0999 can be used. I/O bits are allocated to Basic I/O Units.
	Link Area	3,200 (200 words): CIO 10000 to CIO 119915 (words CIO 1000 to CIO 1199)
	CPU Bus Unit Area	6,400 (400 words): CIO 150000 to CIO 189915 (words CIO 1500 to CIO 1899) CPU Bus Unit bits store operating status of CPU Bus Units. (25 words per Unit, 16 Units max.)
	Inner Board Area	1,600 (100 words): CIO 190000 to CIO 199915 (words CIO 1900 to CIO 1999) Bits in the Inner Board Area are allocated to the display status area.
	C200H Special I/O Unit Area	15,360 (960 words): CIO 200000 to CIO 295915 (words CIO 2000 to CIO 2959) Bits in the Special I/O Area can be allocated to Special I/O Units (10 words per Unit, 96 Units max.)
	DeviceNet Area	9,600 (600 words): CIO 320000 to CIO 379915 (words CIO 3200 to CIO 3799) DeviceNet bits are allocated to Slaves for DeviceNet Section remote I/O communications when the master function is used with fixed allocations. Fixed allocation setting 1 Outputs: CIO 3200 to CIO 3263 Inputs: CIO 3300 to CIO 3363 Fixed allocation setting 2 Outputs: CIO 3400 to CIO 3463 Inputs: CIO 3500 to CIO 3563 Fixed allocation setting 3 Outputs: CIO 3600 to CIO 3663 Inputs: CIO 3700 to CIO 3763 Note: The following words are allocated to the master function even when the DeviceNet Unit is used as a slave. Fixed allocation setting 1 Outputs: CIO 3370 (master to slave) Inputs: CIO 3270 (slave to master) Fixed allocation setting 2 Outputs: CIO 3570 (master to slave) Inputs: CIO 3470 (slave to master) Fixed allocation setting 3 Outputs: CIO 3770 (master to slave) Inputs: CIO 3670 (slave to master)
Work bits	CIO (Core I/O) Area	4,800 (300 words): CIO 120000 to CIO 149915 (words CIO 1200 to CIO 1499) 37,504 (2,344 words): CIO 380000 to CIO 614315 (words CIO 3800 to CIO 6143) These bits in CIO Area are used as work bits in programming to control program execution. They cannot be used for external I/O.
	Work Area	8,192 bits (512 words): W00000 to W51115 (words W000 to W511) Control programs only. (I/O from external I/O terminals is not possible.) Note: When using work bits in programming, use bits in Work Area first before using bits from other areas.
Holding Area		8,192 bits (512 words): H00000 to H51115 (words H000 to H511) Holding bits are used to control execution of program, and maintain their ON/OFF status when the PLC is turned OFF or operating mode is changed. Note: Words H512 to H1535 are allocated to the Function Block Holding Area and are used only for the function block instance area (internally allocated variable area).
Auxiliary Area		Read only: 7,168 bits (448 words): A00000 to A44715 (words A000 to A447) Read/write: 8,192 bits (512 words): A44800 to A95915 (words A448 to A959) Auxiliary bits are allocated specific functions.

The CIO Area can be used as work bits if the bits are not used as shown here.

Controller Section Specifications

Item		Specifications		
Temporary Area		16 bits (TR00 to TR15) Temporary bits are used to store ON/OFF execution conditions at program branches.		
Timer Area		4,096: T0000 to T4095 (used for timers only)		
Counter Area		4,096: C0000 to C4095 (used for counters only)		
DM Area	32 Kwords: D00000 to D32767		Used as a general-purpose data area for reading and writing data in word units (16 bits). Words in the DM Area maintain their status when the NSJ Controller is turned OFF or the operating mode is changed.	
	Special I/O Unit DM Area: D20000 to D29599 (100 words × 96 Units).	Used to set parameters for Special I/O Units.		
	CPU Bus Unit DM Area: D30000 to D31599 (100 words × 16 Units).	Used to set parameters for CPU Bus Units.		
EM Area		NSJ□-□□□□(B)-G5D: 32 Kwords per bank, 3 banks max.: E0_00000 to E2_32767 max. Used as a general-purpose data area for reading and writing data in word units (16 bits). Words in EM Area maintain their status when the NSJ Controller is turned OFF or operating mode is changed. The EM Area is divided into banks, and addresses can be set by either of following methods. Changing current bank using the EMBC (281) instruction and setting addresses for the current bank. Setting bank numbers and addresses directly. EM data can be stored in files by specifying number of first bank. (EM file memory) NSJ□-□□□□(B)-M3D: None		
Index Registers		IR0 to IR15. Store actual memory addresses for indirect addressing. Index registers can be used independently in each task. One register is 32 bits (2 words). Index registers can be specified as shared or independent for each task.		
Task Flag Area		32 (TK0000 to TK0031). Task Flags are read-only flags that are ON when corresponding cyclic task is executable and OFF when corresponding task is not executable or in standby status.		
Trace Memory		4,000 words (traceable data: 31 bits and 6 words)		
File Memory		Memory Cards: Compact flash memory cards can be used (MS-DOS format). EM file memory: Part of EM Area can be converted to file memory (MS-DOS format). The NSJ□-□□□□(B)-M3D does not support EM file memory.		
Functions	Constant cycle time	1 to 32,000 ms (Unit: 1 ms) Note: Using the Parallel Processing Mode will create a constant cycle time for program execution.		
	Cycle time monitoring	Possible (Unit stops operating if cycle is too long): 10 to 40,000 ms (Unit: 10 ms) Note: When the Parallel Processing Mode is used, the program execution cycle is monitored. Controller Section operation will stop if the peripheral servicing time exceeds 2 s.		
	I/O refreshing	Cyclic refreshing, immediate refreshing, refreshing by IORF(097). Note: IORF(097) refreshes I/O bits allocated to Basic I/O Units and Special I/O Units. The CPU BUS UNIT I/O REFRESH (DLNK(226)) instruction can be used to refresh bits allocated to CPU Bus Units in the CIO and DM Areas.		
	Timing of refreshing for CPU Bus Units	Data links for Control Link Units, remote I/O communications for DeviceNet Units, and other special data for CPU Bus Units is refreshed at the following times. During I/O refresh period or when CPU BUS UNIT I/O REFRESH (DLNK(226)) instruction is executed.		
	I/O memory holding when changing operating modes	Depends on ON/OFF status of IOM Hold Bit in Auxiliary Area.		
	Load OFF	All outputs on Output Units can be turned OFF when the Controller Section is operating in RUN, MONITOR, or PROGRAM mode.		
	Timer/counter PV refresh method	BCD or binary (CX-Programmer version 3.0 or higher)		
	Input time constant setting	Time constants can be set for inputs from CJ-series Basic I/O Units. The time constant can be increased to reduce influence of noise and chattering or it can be decreased to detect shorter pulses on inputs.		
	Mode setting at power-up	The operating mode can be specified.		
	Flash memory	<ul style="list-style-type: none"> The user program and parameter area data (e.g., PLC Setup) are always backed up automatically in flash memory. (automatic backup and restore.) When downloading projects from CX-Programmer Ver. 5.0 or higher, symbol table files (including CX-Programmer symbol names, I/O comments), comment files (CX-Programmer rung comments, other comments), and program index files (CX-Programmer section names, section comments, or program comments) are stored in comment memory within the flash memory. 		
	Memory Card functions (Controller Section)	Automatically reading programs (autoboot) from the Memory Card when the power is turned ON.	Possible	
		Program replacement during Controller Section operation	Possible	
		Memory Card storage data	User program: Program file format PLC Setup and other parameters: Data file format I/O memory: Data file format (binary), text format, CSV format	
		Memory Card read/write method	User program instructions, Programming Devices (including CX-Programmer and Programming Console), Host Link computers, Auxiliary Area control bits, easy backup operation	
	Filing (Controller Section)	Memory Card data and EM (Extended Data Memory) Area can be handled as files.		
Debugging	Force-set/reset, differential monitoring, data tracing (scheduled, each cycle, or when instruction is executed), storing location generating error.			

Controller Section Specifications

Item		Specifications				
Functions	Online editing	User programs can be overwritten in program block units when the Controller Section is in MONITOR or PROGRAM mode. This function is not supported for block programming areas. With the CX-Programmer, more than one program block can be edited at the same time.				
	Program protection	Overwrite protection: Set using DIP switch or via the password from CX-Programmer peripheral device. Copy protection: Password set using CX-Programmer.				
	Error check	User-defined errors (i.e., user can define fatal errors and non-fatal errors) The FPD(269) instruction can be used to check execution time and logic of each programming block. Note: FAL and FALS instructions can be used to simulate errors.				
	Error log	Up to 20 errors are stored in error log. Information includes error code, error details, and time error occurred. Note: The Controller Section can be set so that user-defined FAL errors are not stored in the error log.				
	Clock	Provided on all models. Accuracy: <table border="1" data-bbox="475 519 887 577"> <thead> <tr> <th>Ambient temperature</th> <th>Monthly variation</th> </tr> </thead> <tbody> <tr> <td>25°C</td> <td>-1.5 to +1.5 min</td> </tr> </tbody> </table> Note 1. Accuracy varies with the temperature. Note 2. Used to store time when power is turned ON and when errors occur.	Ambient temperature	Monthly variation	25°C	-1.5 to +1.5 min
	Ambient temperature	Monthly variation				
	25°C	-1.5 to +1.5 min				
	Power OFF detection time	2 ms				
	Power OFF detection delay time	0 ms fixed				
	Memory protection	Held Areas: Holding bits, Data Memory, Extended Data Memory, and status of counter Completion Flags and present values. Note: If IOM Hold Bit in Auxiliary Area is turned ON, and PLC Setup is set to maintain IOM Hold Bit status when power to the NSJ Controller is turned ON, contents of CIO Area, Work Area, part of Auxiliary Area, timer Completion Flag and present values, Index Registers, and Data Registers will be saved.				
	Sending commands to a Host Link computer	FINS commands can be sent to a computer connected via Host Link System by executing Network Communications Instructions from the Controller Section.				
	Remote programming and monitoring	Host Link communications can be used for remote programming and remote monitoring through a Controller Link System or Ethernet network.				
	Eight-level communications	Host Link communications can be used for remote programming and remote monitoring from devices on networks up to eight levels away (Controller Link Network, Ethernet Network, or other network).				
	Storing comments in CPU Unit	I/O comments can be stored as symbol table files in Memory Cards in the Controller Section, EM file memory, or Comment Memory (see note). Note: Supported for CX-Programmer Ver. 5.0 or later only.				
Program check	Program checks are performed at the beginning of operation for items such as no END(001) instruction and instruction errors. CX-Programmer can also be used to check programs.					
Battery life	5 years at 25°C (The battery life depends on the ambient operating temperature; 1.1 years min.) (Battery set: CJ1W-BAT01; Use a Replacement Battery that is within two years of its date of manufacture.)					
Self-diagnostics	Controller Section errors (watchdog timer), I/O bus errors, memory errors, and battery errors					
Other functions	Storage of number of times power has been interrupted. (Stored in A514.)					

Display Section Specifications

Model	Built-in ports					Display Section			
	USB port (Slave: For Support Software)	RS-232C port	DeviceNet port	Ethernet port	USB port (Host: For printer)	Display color	Field of view	Language	Standard screen data capacity
NSJ5-SQ10-M3D/-G5D	1 port	3 ports •Display Section: Serial ports A, B •Controller Section: Serial port	1 port	None	None	256 colors (BMP/JPEG, 32,768 colors for images)	Right/left: ±70°, Top: 70°, Bottom: 50° (See note 1.)	Eight languages (See note 2.)	60 MB
NSJ5-SQ10B-M3D/-G5D				10/ 100Base-T					
NSJ5-SQ11-M3D/-G5D				None					
NSJ5-SQ11B-M3D/-G5D				10/ 100Base-T					
NSJ5-TQ10-M3D/-G5D				None					
NSJ5-TQ10B-M3D/-G5D				10/ 100Base-T					
NSJ5-TQ11-M3D/-G5D				None	1 port				
NSJ5-TQ11B-M3D/-G5D				10/ 100Base-T					
NSJ8-TV00-M3D/-G5D				None					
NSJ8-TV00B-M3D/-G5D				10/ 100Base-T					
NSJ8-TV01-M3D/-G5D				None					
NSJ8-TV01B-M3D/-G5D				10/ 100Base-T					
NSJ10-TV00-G5D				None					
NSJ10-TV00B-G5D				10/ 100Base-T					
NSJ10-TV01-G5D				None					
NSJ10-TV01B-G5D				10/ 100Base-T					
NSJ12-TS00-G5D				None					
NSJ12-TS00B-G5D				10/ 100Base-T					
NSJ12-TS01-G5D				None					
NSJ12-TS01B-G5D				10/ 100Base-T					

Note 1. NSJ5-TQ series (high luminance TFT) luminance is better than that of NSJ5-SQ series by about 110cd/m².

Note 2. Japanese, English, Chinese (traditional and simplified), Spanish, Italian, German, and French.

Communications Section Specifications

■ DeviceNet Section

Item	Specifications																
Communications protocol	DeviceNet																
DeviceNet master/slave	Can function as master or slave.																
Connection forms (See note 1.)	Combination of multi-drop and T-branch connections (for trunk or branch lines)																
Terminating resistance.	SW4 (TER) is used to connect/disconnect terminating resistance. The TER indicator lights when terminating resistance is connected.																
Baud rate	500 kbps, 250 kbps, or 125 kbps (Set via DIP switch.)																
Communications distances	<table border="1"> <thead> <tr> <th>Baud rate</th> <th>Network length</th> <th>Branch line length</th> <th>Total branch line length</th> </tr> </thead> <tbody> <tr> <td>500 kbps</td> <td>100 m max.</td> <td>6 m max.</td> <td>39 m max.</td> </tr> <tr> <td>250 kbps</td> <td>250 m max. (See note 2.)</td> <td>6 m max.</td> <td>78 m max.</td> </tr> <tr> <td>125 kbps</td> <td>500 m max. (See note 2.)</td> <td>6 m max.</td> <td>156 m max.</td> </tr> </tbody> </table>	Baud rate	Network length	Branch line length	Total branch line length	500 kbps	100 m max.	6 m max.	39 m max.	250 kbps	250 m max. (See note 2.)	6 m max.	78 m max.	125 kbps	500 m max. (See note 2.)	6 m max.	156 m max.
	Baud rate	Network length	Branch line length	Total branch line length													
	500 kbps	100 m max.	6 m max.	39 m max.													
	250 kbps	250 m max. (See note 2.)	6 m max.	78 m max.													
125 kbps	500 m max. (See note 2.)	6 m max.	156 m max.														
Max. number of Slaves	63 Slaves																
Error control	CRC error check, node address redundancy check, scan list verification																
Cable	Special 5-wire cable (2 signal lines, 2 power lines, 1 shield line)																

Note 1. Terminating resistance is required at both ends of the trunk line.

Note 2. Communications distances are for Thick Cables. Keep the maximum network length to 100 m or less when using Thin Cables.

■ Controller Link (Wired)

Item	Specifications
Communications method	N: N token bus
Code	Manchester code
Modulation	Baseband code
Synchronization	Flag synchronization (conforms to HDLC frames)
Error control	Manchester code checks and CRC checks (CCITT $X^{16}+X^{12}+X^5+1$)
Transmission path form	Multi-drop bus
Baud rate and maximum transmission distance	The maximum transmission distance varies with the baud rate as follows: 2 Mbps: 500 m 1 Mbps: 800 m 500 Kbps: 1 km
Media	Specified shielded twisted-pair cable Number of signal lines: 2, shield line: 1
Node connection method	NSJ Controller Link Unit: Connected via a special connector (included) PLC: Connected to a terminal block IBM PC/AT or compatible: Connected via a special connector (included)
Maximum number of nodes	32 or 62 nodes (See note 1.)
Communications functions	Data links and message service
Number of data link words	<ul style="list-style-type: none"> • Transmission area per node: 1,000 words max. • Data link area (send/receive words) per node NSJ Controller: 20,000 words CS/CJ Series: 20,000 words max. (unit Ver. 1.2 or later) 12,000 words max. (pre-Ver. 1.2) C200HX/HG/HE, CVM1/CV, CQM1H: 8,000 words max. Personal computer: 32,000 or 62,000 words max. (See note 2.)
Data link areas	Bit-access areas (IR, AR, LR, CIO), DM Area (DM), and extended DM Area (EM)
Message length	2,012 bytes max. (including the header)
RAS functions	<ul style="list-style-type: none"> • Polling node backup function • Self-diagnosis function (hardware checking at startup) • Echoback test and broadcast test (using the FINS command) • Watchdog timer • Error log function

Note 1. At least one Repeater Unit (CS1W-RPT01) is required to construct networks that uses a node address higher than 32. The following Controller Link Units/Support Boards must also be used, and the Wired Network 62 Node Enable Bit of the DM Parameter Area software switch of all nodes must be turned ON (62 nodes max.).
CS1W-CLK21-V1, CJ1W-CLK21-V1, 3G8F7-CLK21-V1, and NSJW-CLK21-V1

Note 2. For a maximum configuration of 62 nodes
For other specifications, refer to the Controller Link Unit Operation Manual (Cat. No. W309).

Communications Section Specifications

■Ethernet Unit

Item	Specifications	
Type	100Base-TX (can be used as 10Base-T)	
Media access method	CSMA/CD	
Modulation method	Baseband	
Transmission paths	Star form	
Baud rate	100 Mbps (100Base-TX)	100 Mbps (10Base-T)
Transmission media	Unshielded twisted-pair (UTP) cable Categories: 5, 5e Shielded twisted-pair (STP) cable Categories: 100 Ω at 5, 5e	Unshielded twisted-pair (UTP) cable Categories: 3, 4, 5, 5e Shielded twisted-pair (STP) cable Categories: 100 Ω at 3, 4, 5, 5e
Transmission distance	100 m (distance between hub and node)	
Number of cascade connections	2	4
Functions	<ul style="list-style-type: none"> • FINS communications service • Socket services (UDP/TCP) • FTP server • Email send/receive • Automatic clock adjustment 	

Note: Refer to the Ethernet Units Construction of Networks Operation Manual (Cat. No. W420) and the Ethernet Units Construction of Applications Operation Manual (Cat. No. W421) for other specifications.

■Differences between the Built-in Ethernet and Ethernet Unit Ports

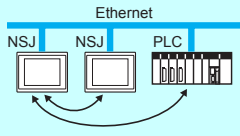
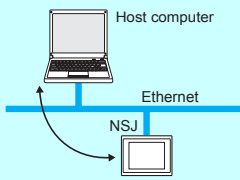
	Built-in Ethernet port	Ethernet Unit port
<p>Communications with another host (PLC)</p> 	<p>Communications is possible with another host via Ethernet. For example, from one NSJ Controller, data can be displayed or settings can be made to another NSJ Controller or PLC.</p>	<p>Same functions as at left.</p>
<p>Connection with a host computer</p> 	<p> ■Support Software Connections CX-One (CX-Programmer, CX-Designer, etc.) can be used via Ethernet. Screen data and ladder programs can be transferred from a host computer. ■Access to a Memory Card in the Display Section A memory card in the Display Section can be accessed using Support Software or FTP and Ethernet. For example, Display Section recipe data and alarm or data log files can be downloaded from a host computer. ■Access to the Host from a Host Application A host computer can access the Controller Section using FINS communications. For example, an application on a host computer can read or data can be written to the NSJ data memory (DM) (UDP only). </p>	<p>Same functions as at left, plus the following:</p> <ul style="list-style-type: none"> • A Memory Card in the Controller Section can be accessed. • The clock can be set using SNTP • TCP/IP support (See note.) (The Memory Card in the Display Section cannot be accessed.) <p>Note: Ethernet (FINS/TCP) not supported by CX-Programmer.</p>
E-mail	---	E-mail can be sent and received.
Communications using ladder programming	---	<ul style="list-style-type: none"> • Socket communications are possible using the CMND instruction. • SEND/RCV instructions

■ Ordering Information

Product name	Specifications			Model	Standards
		Number of licenses	Media		
FA Integrated Tool Package CX-One Ver.4.□	The CX-One is a comprehensive software package that integrates Support Software for OMRON PLCs and components. CX-One runs on the following OS. OS: Windows 2000 (Service Pack 4 or higher), XP, Vista, or 7 (except 64-bit edition) CX-One Ver.4.□ includes CX-Designer Ver.3.□. For details, refer to the <i>CX-One catalog</i> (Cat. No. R134).	1 licence (See note.)	CD	CXONE-AL01C-V4	---
			DVD	CXONE-AL01D-V4	
The CX-Designer can still be ordered individually in the following model numbers.					
CX-Designer Ver.3.□	Screen Designer for NS Series OS: Windows 2000 (Service Pack 4 or higher), XP, Vista, or 7 (except 64-bit edition) The Ladder Monitor Software is included with CX-Designer Ver.3.□. Note: The Ladder Monitor Software is used to monitor CS/CJ-series PLC ladder programs from an NS-series PT. A Memory Card and Memory Card Adapter (both sold separately) are required to use the Ladder Monitor Software with the NS8-V1, NS10-V1, or NS12-V1, or with the NS8-V2, NS10-V2, or NS12-V2 with system program version 6.6 or lower.	1 license	CD	NS-CXDC1-V3	---

Note: Multi licenses are available for the CX-One (3, 10, 30, or 50 licenses).

Dimensions

(Unit: mm)

NSJ12-TS0□(B)-G5D

NSJ10-TV0□(B)-G5D

With NSJW-CLK21-V1 Mounted

No Expansion Unit

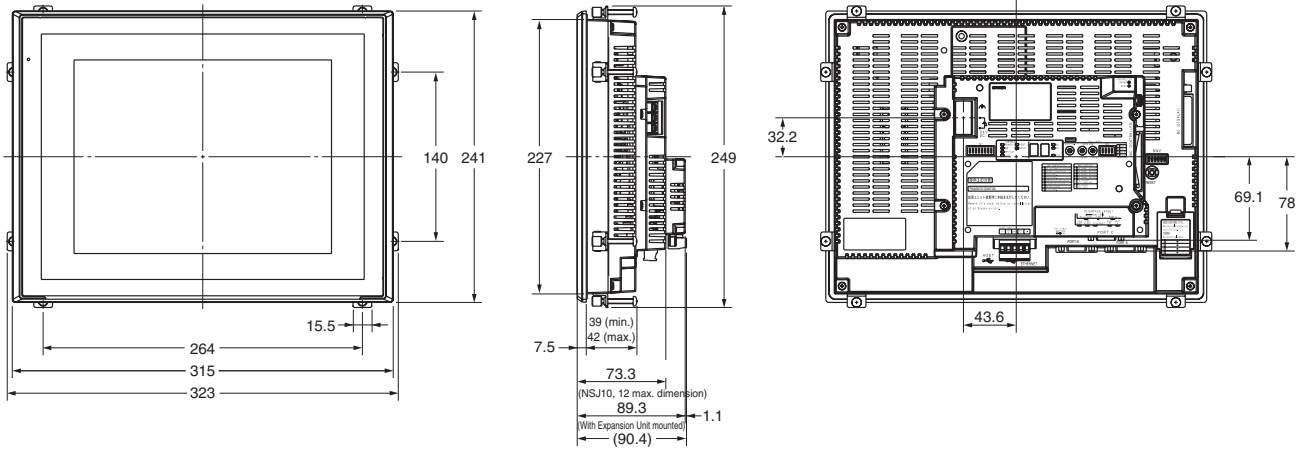

NSJ8-TV0□(B)-M3D

NSJ8-TV0□(B)-G5D

With NSJW-CLK21-V1 Mounted

No Expansion Unit

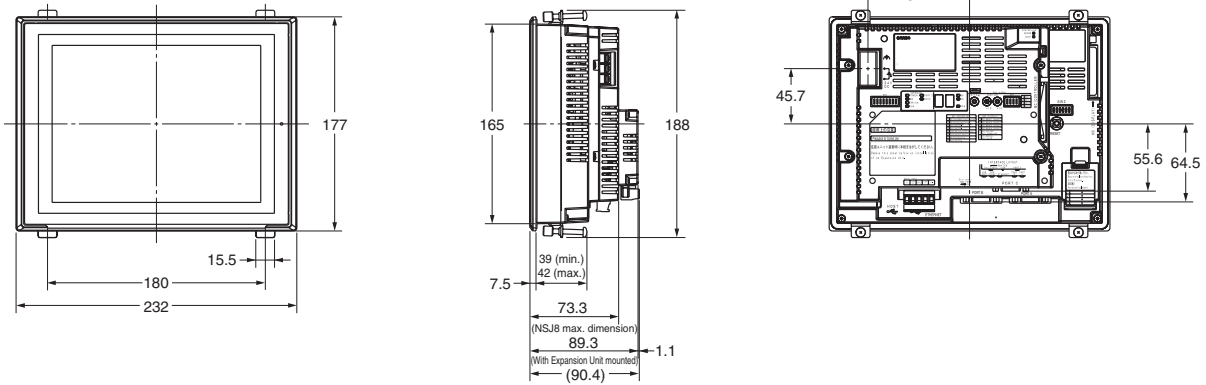

NSJ5-TQ1□(B)-M3D

NSJ5-TQ1□(B)-G5D

NSJ5-SQ1□(B)-M3D

NSJ5-SQ1□(B)-G5D

With NSJW-CLK21-V1 Mounted

No Expansion Unit

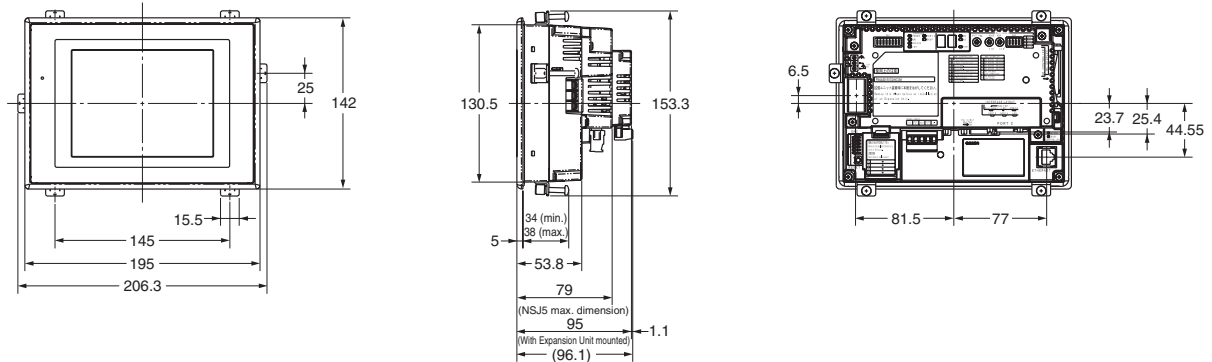

Terms and Conditions of Sale

- Offer; Acceptance.** These terms and conditions (these "Terms") are deemed part of all quotes, agreements, purchase orders, acknowledgments, price lists, catalogs, manuals, brochures and other documents, whether electronic or in writing, relating to the sale of products or services (collectively, the "Products") by Omron Electronics LLC and its subsidiary companies ("Omron"). Omron objects to any terms or conditions proposed in Buyer's purchase order or other documents which are inconsistent with, or in addition to, these Terms.
- Prices; Payment Terms.** All prices stated are current, subject to change without notice by Omron. Omron reserves the right to increase or decrease prices on any unshipped portions of outstanding orders. Payments for Products are due net 30 days unless otherwise stated in the invoice.
- Discounts.** Cash discounts, if any, will apply only on the net amount of invoices sent to Buyer after deducting transportation charges, taxes and duties, and will be allowed only if (i) the invoice is paid according to Omron's payment terms and (ii) Buyer has no past due amounts.
- Interest.** Omron, at its option, may charge Buyer 1-1/2% interest per month or the maximum legal rate, whichever is less, on any balance not paid within the stated terms.
- Orders.** Omron will accept no order less than \$200 net billing.
- Governmental Approvals.** Buyer shall be responsible for, and shall bear all costs involved in, obtaining any government approvals required for the importation or sale of the Products.
- Taxes.** All taxes, duties and other governmental charges (other than general real property and income taxes), including any interest or penalties thereon, imposed directly or indirectly on Omron or required to be collected directly or indirectly by Omron for the manufacture, production, sale, delivery, importation, consumption or use of the Products sold hereunder (including customs duties and sales, excise, use, turnover and license taxes) shall be charged to and remitted by Buyer to Omron.
- Financial.** If the financial position of Buyer at any time becomes unsatisfactory to Omron, Omron reserves the right to stop shipments or require satisfactory security or payment in advance. If Buyer fails to make payment or otherwise comply with these Terms or any related agreement, Omron may (without liability and in addition to other remedies) cancel any unshipped portion of Products sold hereunder and stop any Products in transit until Buyer pays all amounts, including amounts payable hereunder, whether or not then due, which are owing to it by Buyer. Buyer shall in any event remain liable for all unpaid accounts.
- Cancellation; Etc.** Orders are not subject to rescheduling or cancellation unless Buyer indemnifies Omron against all related costs or expenses.
- Force Majeure.** Omron shall not be liable for any delay or failure in delivery resulting from causes beyond its control, including earthquakes, fires, floods, strikes or other labor disputes, shortage of labor or materials, accidents to machinery, acts of sabotage, riots, delay in or lack of transportation or the requirements of any government authority.
- Shipping; Delivery.** Unless otherwise expressly agreed in writing by Omron:
 - Shipments shall be by a carrier selected by Omron; Omron will not drop ship except in "break down" situations.
 - Such carrier shall act as the agent of Buyer and delivery to such carrier shall constitute delivery to Buyer;
 - All sales and shipments of Products shall be FOB shipping point (unless otherwise stated in writing by Omron), at which point title and risk of loss shall pass from Omron to Buyer; provided that Omron shall retain a security interest in the Products until the full purchase price is paid;
 - Delivery and shipping dates are estimates only; and
 - Omron will package Products as it deems proper for protection against normal handling and extra charges apply to special conditions.
- Claims.** Any claim by Buyer against Omron for shortage or damage to the Products occurring before delivery to the carrier must be presented in writing to Omron within 30 days of receipt of shipment and include the original transportation bill signed by the carrier noting that the carrier received the Products from Omron in the condition claimed.
- Warranties.** (a) **Exclusive Warranty.** Omron's exclusive warranty is that the Products will be free from defects in materials and workmanship for a period of twelve months from the date of sale by Omron (or such other period expressed in writing by Omron). Omron disclaims all other warranties, express or implied. (b) **Limitations.** OMRON MAKES NO WARRANTY OR REPRESENTATION, EXPRESS OR IMPLIED, ABOUT NON-INFRINGEMENT, MERCHANTABILITY OR FITNESS FOR A PARTICULAR PURPOSE OF THE PRODUCTS. BUYER ACKNOWLEDGES THAT IT ALONE HAS DETERMINED THAT THE PRODUCTS WILL SUITABLY MEET THE REQUIREMENTS OF THEIR INTENDED USE. Omron further disclaims all warranties and responsibility of any type for claims or expenses based on infringement by the Products or otherwise of any intellectual property right. (c) **Buyer Remedy.** Omron's sole obligation hereunder shall be, at Omron's election, to (i) replace (in the form originally shipped with Buyer responsible for labor charges for removal or replacement thereof) the non-complying Product, (ii) repair the non-complying Product, or (iii) repay or credit Buyer an amount equal to the purchase price of the non-complying Product; provided that in no event shall Omron be responsible for warranty, repair, indemnity or any other claims or expenses regarding the Products unless Omron's analysis confirms that the Products were properly handled, stored, installed and maintained and not subject to contamination, abuse, misuse or inappropriate modification. Return of any Products by Buyer must be approved in writing by Omron before shipment. Omron Companies shall not be liable for the suitability or unsuitability or the results from the use of Products in combination with any electrical or electronic components, circuits, system assemblies or any other materials or substances or environments. Any advice, recommendations or information given orally or in writing, are not to be construed as an amendment or addition to the above warranty. See <http://www.omron247.com> or contact your Omron representative for published information.
- Limitation on Liability; Etc.** OMRON COMPANIES SHALL NOT BE LIABLE FOR SPECIAL, INDIRECT, INCIDENTAL, OR CONSEQUENTIAL DAMAGES, LOSS OF PROFITS OR PRODUCTION OR COMMERCIAL LOSS IN ANY WAY CONNECTED WITH THE PRODUCTS, WHETHER SUCH CLAIM IS BASED IN CONTRACT, WARRANTY, NEGLIGENCE OR STRICT LIABILITY. Further, in no event shall liability of Omron Companies exceed the individual price of the Product on which liability is asserted.
- Indemnities.** Buyer shall indemnify and hold harmless Omron Companies and their employees from and against all liabilities, losses, claims, costs and expenses (including attorney's fees and expenses) related to any claim, investigation, litigation or proceeding (whether or not Omron is a party) which arises or is alleged to arise from Buyer's acts or omissions under these Terms or in any way with respect to the Products. Without limiting the foregoing, Buyer (at its own expense) shall indemnify and hold harmless Omron and defend or settle any action brought against such Companies to the extent based on a claim that any Product made to Buyer specifications infringed intellectual property rights of another party.
- Property; Confidentiality.** Any intellectual property in the Products is the exclusive property of Omron Companies and Buyer shall not attempt to duplicate it in any way without the written permission of Omron. Notwithstanding any charges to Buyer for engineering or tooling, all engineering and tooling shall remain the exclusive property of Omron. All information and materials supplied by Omron to Buyer relating to the Products are confidential and proprietary, and Buyer shall limit distribution thereof to its trusted employees and strictly prevent disclosure to any third party.
- Export Controls.** Buyer shall comply with all applicable laws, regulations and licenses regarding (i) export of products or information; (ii) sale of products to "forbidden" or other proscribed persons; and (iii) disclosure to non-citizens of regulated technology or information.
- Miscellaneous.** (a) **Waiver.** No failure or delay by Omron in exercising any right and no course of dealing between Buyer and Omron shall operate as a waiver of rights by Omron. (b) **Assignment.** Buyer may not assign its rights hereunder without Omron's written consent. (c) **Law.** These Terms are governed by the law of the jurisdiction of the home office of the Omron company from which Buyer is purchasing the Products (without regard to conflict of law principles). (d) **Amendment.** These Terms constitute the entire agreement between Buyer and Omron relating to the Products, and no provision may be changed or waived unless in writing signed by the parties. (e) **Severability.** If any provision hereof is rendered ineffective or invalid, such provision shall not invalidate any other provision. (f) **Setoff.** Buyer shall have no right to set off any amounts against the amount owing in respect of this invoice. (g) **Definitions.** As used herein, "including" means "including without limitation"; and "Omron Companies" (or similar words) mean Omron Corporation and any direct or indirect subsidiary or affiliate thereof.

Certain Precautions on Specifications and Use

- Suitability of Use.** Omron Companies shall not be responsible for conformity with any standards, codes or regulations which apply to the combination of the Product in the Buyer's application or use of the Product. At Buyer's request, Omron will provide applicable third party certification documents identifying ratings and limitations of use which apply to the Product. This information by itself is not sufficient for a complete determination of the suitability of the Product in combination with the end product, machine, system, or other application or use. Buyer shall be solely responsible for determining appropriateness of the particular Product with respect to Buyer's application, product or system. Buyer shall take application responsibility in all cases but the following is a non-exhaustive list of applications for which particular attention must be given:
 - Outdoor use, uses involving potential chemical contamination or electrical interference, or conditions or uses not described in this document.
 - Use in consumer products or any use in significant quantities.
 - Energy control systems, combustion systems, railroad systems, aviation systems, medical equipment, amusement machines, vehicles, safety equipment, and installations subject to separate industry or government regulations.
 - Systems, machines and equipment that could present a risk to life or property. Please know and observe all prohibitions of use applicable to this Product.

NEVER USE THE PRODUCT FOR AN APPLICATION INVOLVING SERIOUS RISK TO LIFE OR PROPERTY OR IN LARGE QUANTITIES WITHOUT ENSURING THAT THE SYSTEM AS A WHOLE HAS BEEN DESIGNED TO ADDRESS THE RISKS, AND THAT THE OMRON'S PRODUCT IS PROPERLY RATED AND INSTALLED FOR THE INTENDED USE WITHIN THE OVERALL EQUIPMENT OR SYSTEM.
- Programmable Products.** Omron Companies shall not be responsible for the user's programming of a programmable Product, or any consequence thereof.
- Performance Data.** Data presented in Omron Company websites, catalogs and other materials is provided as a guide for the user in determining suitability and does not constitute a warranty. It may represent the result of Omron's test conditions, and the user must correlate it to actual application requirements. Actual performance is subject to the Omron's Warranty and Limitations of Liability.
- Change in Specifications.** Product specifications and accessories may be changed at any time based on improvements and other reasons. It is our practice to change part numbers when published ratings or features are changed, or when significant construction changes are made. However, some specifications of the Product may be changed without any notice. When in doubt, special part numbers may be assigned to fix or establish key specifications for your application. Please consult with your Omron's representative at any time to confirm actual specifications of purchased Product.
- Errors and Omissions.** Information presented by Omron Companies has been checked and is believed to be accurate; however, no responsibility is assumed for clerical, typographical or proofreading errors or omissions.



OMRON ELECTRONICS LLC • THE AMERICAS HEADQUARTERS • Schaumburg, IL USA • 847.843.7900 • 800.556.6766 • www.omron247.com

OMRON CANADA, INC. • HEAD OFFICE

Toronto, ON, Canada • 416.286.6465 • 866.986.6766
www.omron247.com

OMRON ELETRÔNICA DO BRASIL LTDA • HEAD OFFICE

São Paulo, SP, Brasil • 55.11.2101.6300 • www.omron.com.br

OMRON ELECTRONICS MEXICO SA DE CV • HEAD OFFICE

Apodaca, N.L. • 52.811.156.99.10 • 001.800.556.6766 • mela@omron.com

OMRON ARGENTINA • SALES OFFICE

Cono Sur • 54.11.4783.5300

OMRON CHILE • SALES OFFICE

Santiago • 56.9.9917.3920

OTHER OMRON LATIN AMERICA SALES

54.11.4783.5300

OMRON EUROPE B.V. Wegalaan 67-69, NL-2132 JD, Hoofddorp, The Netherlands. Tel: +31 (0) 23 568 13 00 Fax: +31 (0) 23 568 13 88 www.industrial.omron.eu