

MINI-CON-X[®]
SEALED CONNECTORS
AND CABLES

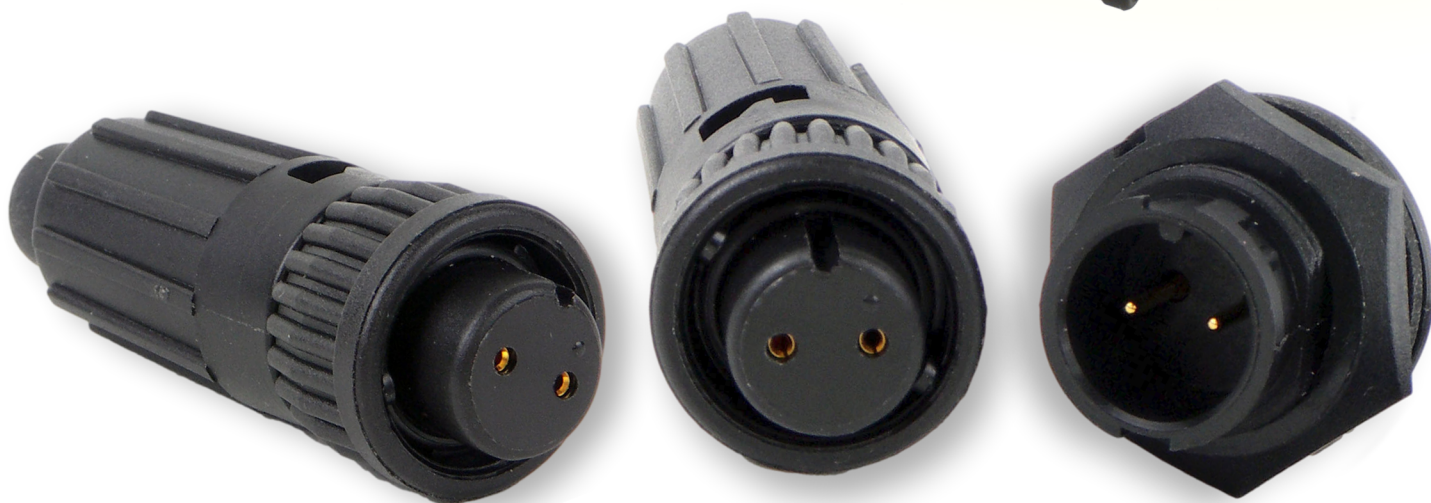

Switchcraft[®]
CONXALL[®]

HARSH ENVIRONMENT CONNECTIVITY SOLUTIONS

Mini-Con-X® Sealed Connectors

Thousands of configurations are available up to 10 contacts with a variety of options

Coupling rings have overriding locking features to prevent loosening or separation of connector



Mixed contact styles also available

Available as field installable connectors or factory molded cable assemblies

Available with solder, crimp, PC mount, and right angle PC mount style contacts

CONXALL® PRODUCT

The Mini Con X® series from Conxall® sets the standard for sealed circular connectors. It is built to withstand harsh environments with an IP67/IP69K seal rating, and a 600V voltage rating makes it an ideal solution for power or signal. Thousands of configurations are available up to 10 contacts, including standard off the shelf or custom molded cable assemblies.

IP67/IP69K
RATED WATER
RESISTANCE

The Con-X® series is sealed to IP67/IP69K for harsh environments when used with a molded cable assembly.



600V VOLTAGE
RATING

600V voltage rating makes it an ideal solution for power or signal.



CONXALL
QUALITY

Made in USA to the high standards that have made Conxall® the leading name in harsh environment connectors.

MINI-CON-X® LINE



CABLE END - SOCKET

MATES WITH PANEL MOUNT AND
CABLE TO CABLE



CABLE END - PIN

MATES WITH PANEL MOUNT AND
CABLE TO CABLE



CABLE TO CABLE / INLINE - PIN

MATES WITH CABLE END



PANEL MOUNT - PIN

MATES WITH CABLE END



PANEL MOUNT - SOCKET

MATES WITH CABLE END

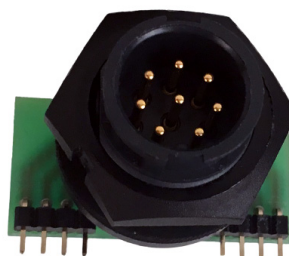

RIGHT ANGLE PCB MOUNT - WIDE

MATES WITH CABLE END



RIGHT ANGLE PCB MOUNT - NARROW

MATES WITH CABLE END



MIXED SIGNAL/POWER- CABLE END

MATES WITH PANEL MOUNT AND
CABLE TO CABLE



MIXED SIGNAL/POWER- CABLE TO CABLE

MATES WITH PANEL MOUNT AND
CABLE TO CABLE



MIXED SIGNAL/POWER - PANEL MOUNT

MATES WITH CABLE END

Mini-Con-X® Sealed Connectors



MOLDED RIGHT ANGLE CABLE ASSEMBLY
FLEX RELIEF STYLE



MOLDED CABLE TO CABLE ASSEMBLY
FLEX RELIEF STYLE



MOLDED CABLE END ASSEMBLY
FLEX RELIEF STYLE



MOLDED CABLE END ASSEMBLY
BULLET STYLE



MOLDED CABLE TO CABLE ASSEMBLY
BULLET STYLE



MOLDED RIGHT ANGLE CABLE ASSEMBLY
BULLET STYLE



DUST CAP
P/N - 6295



IP RATED LOCKING CAP
P/N - 6295P-W



IP RATED CAP WITH LANYARD
P/N - 6295N-WL

INSTA-CLICK®
AVAILABLE

- Automatic Positive Lock
- IP68 Seal Rating
- UL F1 Rated UV Resistance



FIELD INSTALLABLE KITS

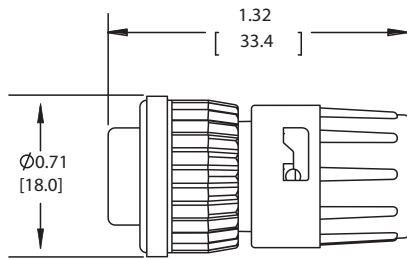

6XXX-XXG-3XX
FIELD INSTALLABLE
CABLE CONNECTOR
TWIST LOCK BACKSHELL
TYPE 3-SHORT

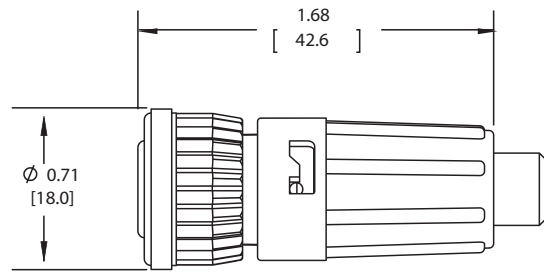

6XXX-XXG-5XX
FIELD INSTALLABLE
CABLE CONNECTOR
TWIST LOCK BACKSHELL
TYPE 5-LONG

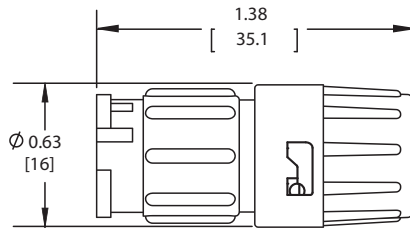

8XXX-XXG-3XX
FIELD INSTALLABLE
CABLE TO CABLE CONNECTOR
TWIST LOCK BACKSHELL
TYPE 3-SHORT

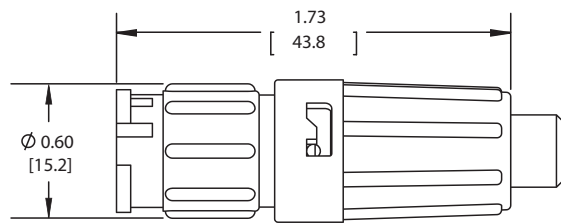

8XXX-XXG-5XX
FIELD INSTALLABLE
CABLE TO CABLE CONNECTOR
TWIST LOCK BACKSHELL
TYPE 5-LONG

PANEL MOUNT ASSEMBLY KITS

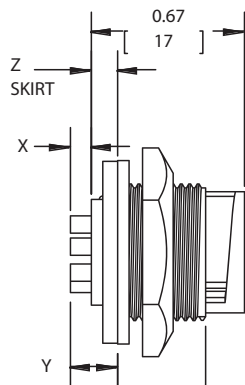

7X80-XXG-3XX
PANEL MOUNT CONNECTOR
CRIMP

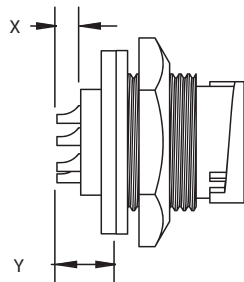

7X82-XXG-3XX
PANEL MOUNT CONNECTOR
SOLDER CUP

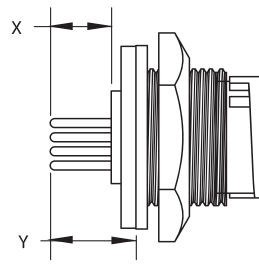

7XXX-XXG-3XX
PANEL MOUNT CONNECTOR
PC TAIL

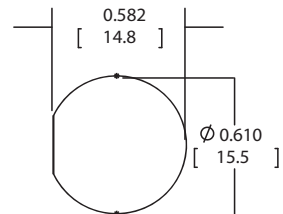
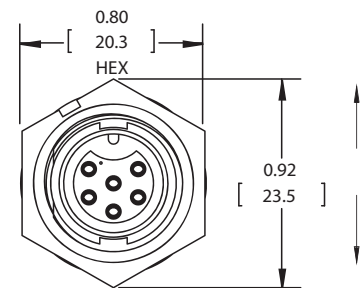

RECOMMENDED
PANEL CUT-OUT
TOLERANCE: ± 0.003 [0.08]

*X, Y, Z - Consult Factory. All dimensions are for reference only. Units shown: in[mm].

Mini-Con-X® Sealed Connectors

PANEL MOUNT / CABLE TO CABLE CONNECTORS Front View | Wire View

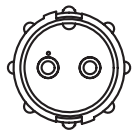

2 POSITION
#16 PIN & SOCKET
CONTACT

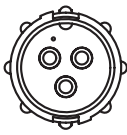

3 POSITION
#16 PIN & SOCKET
CONTACT

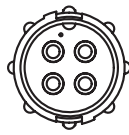

4 POSITION
#16 PIN & SOCKET
CONTACT

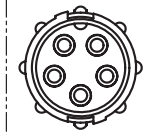

5 POSITION
#16 PIN
CONTACT

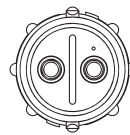

2 POSITION
#16 PIN & SOCKET
CONTACT

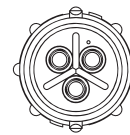

3 POSITION
#16 PIN & SOCKET
CONTACT

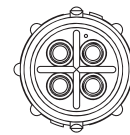

4 POSITION
#16 PIN & SOCKET
CONTACT

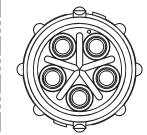

5 POSITION
#16 PIN
CONTACT

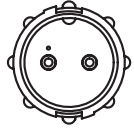

2 POSITION
#20 PIN & SOCKET
CONTACT

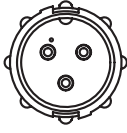

3 POSITION
#20 PIN & SOCKET
CONTACT

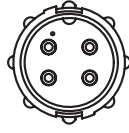

4 POSITION
#20 PIN & SOCKET
CONTACT

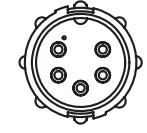

5 POSITION
#20 PIN & SOCKET
CONTACT

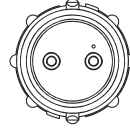

2 POSITION
#20 PIN & SOCKET
CONTACT

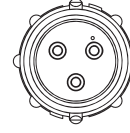

3 POSITION
#20 PIN & SOCKET
CONTACT

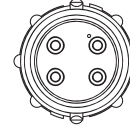

4 POSITION
#20 PIN & SOCKET
CONTACT

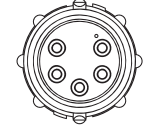

5 POSITION
#20 PIN & SOCKET
CONTACT

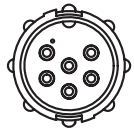

6 POSITION
#20 PIN & SOCKET
CONTACT



7 POSITION
#20 PIN
CONTACT



8 POSITION
#20 PIN
CONTACT



9 POSITION
#22 PIN & SOCKET
CONTACT

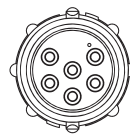

6 POSITION
#20 PIN & SOCKET
CONTACT

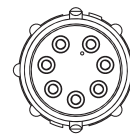

7 POSITION
#20 PIN
CONTACT

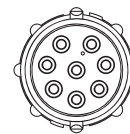

8 POSITION
#20 PIN
CONTACT

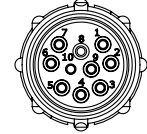

9 POSITION
#22 PIN & SOCKET
CONTACT



10 POSITION
#22 PIN & SOCKET
CONTACT

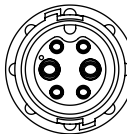

6 POSITION
2#16/4#20
PIN & SOCKET

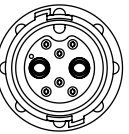

8 POSITION
2#16#/6#26
PIN & SOCKET

CABLE CONNECTORS Front View | Wire View

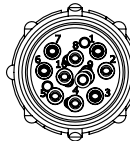

10 POSITION
#22 PIN & SOCKET
CONTACT

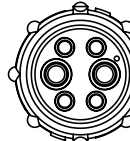

6 POSITION
2#16/4#20
PIN & SOCKET

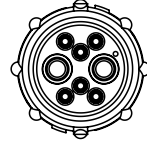

8 POSITION
2#16/6#26
PIN & SOCKET



2 POSITION
#16 PIN & SOCKET
CONTACT



3 POSITION
#16 PIN & SOCKET
CONTACT



4 POSITION
#16 PIN & SOCKET
CONTACT



5 POSITION
#16 SOCKET
CONTACT

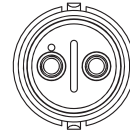

2 POSITION
#16 PIN & SOCKET
CONTACT



3 POSITION
#16 PIN & SOCKET
CONTACT



4 POSITION
#16 PIN & SOCKET
CONTACT

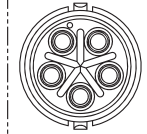

5 POSITION
#16 SOCKET
CONTACT

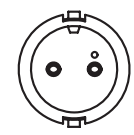

2 POSITION
#20 PIN & SOCKET
CONTACT

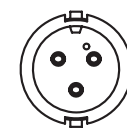

3 POSITION
#20 PIN & SOCKET
CONTACT

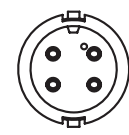

4 POSITION
#20 PIN & SOCKET
CONTACT



5 POSITION
#20 PIN & SOCKET
CONTACT

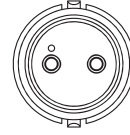

2 POSITION
#20 PIN & SOCKET
CONTACT

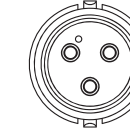

3 POSITION
#20 PIN & SOCKET
CONTACT

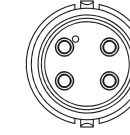

4 POSITION
#20 PIN & SOCKET
CONTACT

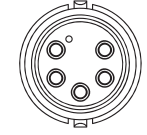

5 POSITION
#20 PIN & SOCKET
CONTACT

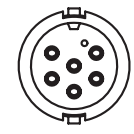

6 POSITION
#20 PIN & SOCKET
CONTACT

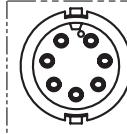

7 POSITION
#20 SOCKET
CONTACT

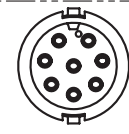

8 POSITION
#20 SOCKET
CONTACT



9 POSITION
#22 PIN & SOCKET
CONTACT

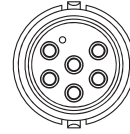

6 POSITION
#20 PIN & SOCKET
CONTACT

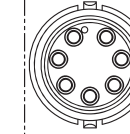

7 POSITION
#20 SOCKET
CONTACT

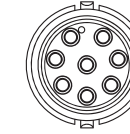

8 POSITION
#20 SOCKET
CONTACT

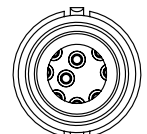

9 POSITION
#22 PIN & SOCKET
CONTACT

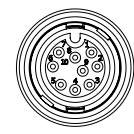

10 POSITION
#22 PIN & SOCKET
CONTACT

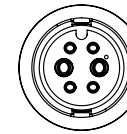

6 POSITION
2#16/4#20
PIN & SOCKET

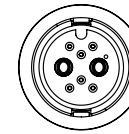

8 POSITION
2#16#/6#26
PIN & SOCKET

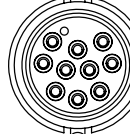

10 POSITION
#22 PIN & SOCKET
CONTACT

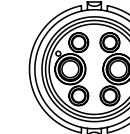

6 POSITION
2#16/4#20
PIN & SOCKET

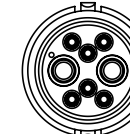

8 POSITION
2#16#/6#26
PIN & SOCKET

CUSTOM MOLDED CABLE ASSEMBLIES

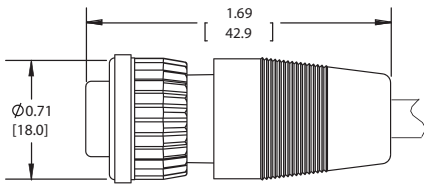

6XXX-XXG
CUSTOM CABLE CONNECTOR
STRAIGHT OVERMOLDED
BULLET STYLE

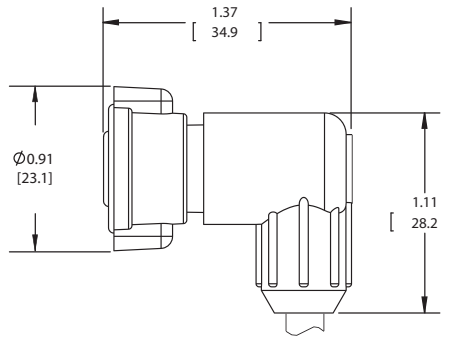

6XXX-XXG
CUSTOM CABLE CONNECTOR
RIGHT ANGLE OVERMOLDED
BULLET STYLE

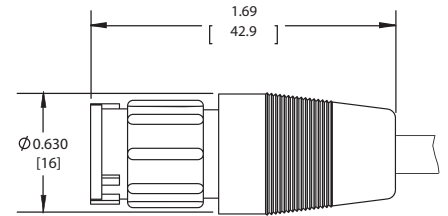

8XXX-XXG
CUSTOM CABLE TO CABLE CONNECTOR
STRAIGHT OVERMOLDED
BULLET STYLE

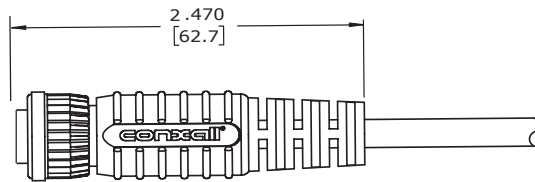

CA6280XPXXX90
CUSTOM CABLE CONNECTOR
STRAIGHT OVERMOLDED
FLEX RELIEF STYLE

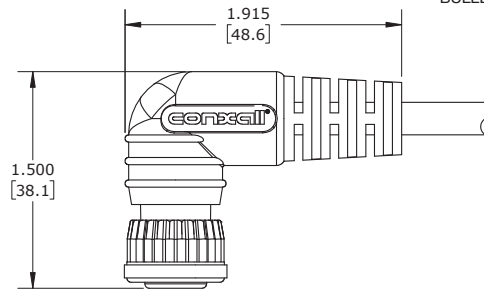

CA6280XPXXX90
CUSTOM CABLE CONNECTOR
RIGHT ANGLE OVERMOLDED
FLEX RELIEF STYLE

Configuration	Mini-Con-X® Part Number
Straight, 2-pos, Male, 2 Meter	CA62802P07990
Straight, 2-pos, Female, 2 Meter	CA62802S07990
Straight, 3-pos, Male, 2 Meter	CA62803P07990
Straight, 3-pos, Female, 2 Meter	CA62803S07990
Straight, 4-pos, Male, 2 Meter	CA62804P07990
Straight, 4-pos, Female, 2 Meter	CA62804S07990
Straight, 5-pos, Male, 2 Meter	CA62805P07990
Straight, 5-pos, Female, 2 Meter	CA62805S07990
Straight, 6-pos, Male, 2 Meter	CA62806P07990
Straight, 6-pos, Female, 2 Meter	CA62806S07990
Straight, 8-pos, Female, 2 Meter	CA62808S07990
Right Angle, 2-pos, Male, 2 Meter	CARA62802P07990
Right Angle, 2-pos, Female, 2 Meter	CARA62802S07990
Right Angle, 3-pos, Male, 2 Meter	CARA62803P07990
Right Angle, 3-pos, Female, 2 Meter	CARA62803S07990
Right Angle, 4-pos, Male, 2 Meter	CARA62804P07990
Right Angle, 4-pos, Female, 2 Meter	CARA62804S07990
Right Angle, 5-pos, Male, 2 Meter	CARA62805P07990
Right Angle, 5-pos, Female, 2 Meter	CARA62805S07990

PART NUMBER TO ORDER

X X X XX - XXG - XXX X

Special Features

BLANK - Standard Material
"W" - UV Resistant Material

Special Features

"W" - Winged Coupling Nut

Connector Type

6 - Cable End
7 - Panel mount
8 - Cable to Cable

Backshell Style - Snap Lock

with Grommet (Cable O.D. Range)

3DC - 3 Grommet Sizes

3XX - Short Backshell (2&3 Contacts Only)

"11" - 0.09" - 0.14" [2.3 to 3.6mm]

"15" - 0.15" - 0.17" [3.8 to 4.3mm]

"18" - 0.18" - 0.20" [4.6 to 5.1mm]

"21" - 0.21" - 0.23" [5.3 to 5.8mm]

5XX - Long Backshell (2-10 Contacts)

"13" - 0.13" - 0.15" [3.3 to 3.8mm]

"16" - 0.16" - 0.18" [4.1 to 4.6mm]

"19" - 0.19" - 0.21" [4.8 to 5.3mm]

"22" - 0.22" - 0.25" [5.6 to 6.3mm]

"26" - 0.25" - 0.27" [6.3 to 6.8mm]

"28" - 0.26" - 0.29" [6.6 to 7.2mm]

Contact Size

2 - #20
3 - #16
8 - #22
A - 2 #16 / 6 #26
C - 2 #16 / 4 #20

Panel Mount

with Hex Nut & Gasket

3ES - with Epoxy

300 - without Epoxy

Contact Style

8X - **"0"** - Crimp
"1" - PC Tail Short*
"2" - Solder
9X - Extended PC Tail
"1" - #20 PC Tail Medium*
"2" - #20 PC Tail Long*

Gold Plated

No. & Type of Contacts

Pin or Socket

***Consult factory for length and diameter of PC Tail. Additionally, alternative colors and materials are available. Mixed contact sizes and #22 contacts only available with "W" UV Resistant material. Visit Switchcraft.com for Insta-Click® ordering code**

COLOR CODED CON-X® LINE



CC2

CH2

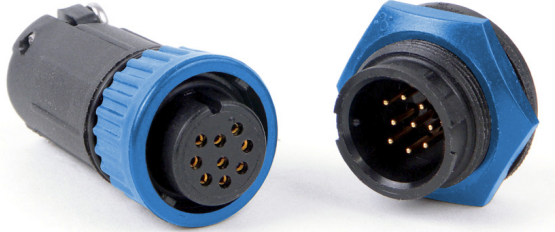

CC3

CH3



CC5

CH5



CC7

CH7

ORDERING CODE

Added to the end of your standard Con-X part number

When ordering, use the following code to specify your special feature:

Special Features

CXX = Color Options

└─ Color Designator - see below

└─ Part Designator - see below

└─ Special Feature Designator - see below

Special Feature Designator = C (Color Option)

Part Designator = H (Hex Nut)

C (Coupling Ring-standard)*

Color Designator= 2 (Red)

3 (Blue)

5 (Yellow)

7 (Green)

*Winged coupling ring available on request.
Contact factory for more information.

SPECIFICATIONS

MECHANICAL:

Life:	300 insertion / withdrawal cycles minimum
Vibration:	Coupling rings have overriding locking feature to prevent loosening/separation of connector
Hex Nut Torque:	9 in-lb tightening torque
Coupling Locking Style:	Bayonet with ribbed coupling nut (winged coupling nut available) P/N 16482
Backshell Style:	Removable twist lock
Conductor Sizes:	#16 accepts 16 through 18 AWG #20 contacts accepts 20 through 24 AWG

ELECTRICAL:

Voltage Rating:	600 V AC/DC
Current Rating:	13.0 A - max (See Electrical Current Rating Chart)

ENVIRONMENTAL:

Operating Temperature:	-40°C to +85°C (-40°F to +185°F)
Salt Atmosphere (Corrosion) :	300 Hr salt spray when mated
Weathertight:	IP67/IP69K when mated

MATERIAL:

Backshell:	Thermoplastic, UL 94HB, Black
Contacts:	Copper Alloy, Gold over Nickel Plate
Coupling Ring:	Thermoplastic, UL 94HB, Black
Gasket:	Elastomer, Black
Grommet/ Strain Relief:	Elastomer, Black
Hex Nut:	Thermoplastic, UL 94HB, Black
O-Ring:	Elastomer, Black
Shell:	Thermoplastic, UL 94HB, Black
Optional Dust Cap:	Elastomer, Black

CON-X® ELECTRICAL CURRENT RATING CHART

CONTACT SIZE	CONDUCTOR SIZE - AWG	NUMBER OF CONDUCTORS	CURRENT RATING
#12	#12	1 through 7	23.0A
	#14	1 through 3	17.0A
		4 through 6	12.75A
		7 through 9	11.0A
	#16	1 through 3	13.0A
		4 through 6	9.75A
7		8.45A	
#16	#16	1 through 10	13.0A
		11 and 12	7.5A
	#18	1 through 3	10.0A
		4 through 12	7.5A
#20	#18	1 through 3	7.5A
		4 through 20	5.6A
		21 through 31	2.3A
	#20	1 through 3	7.5A
		4 through 20	5.6A
		21 through 31	2.3A
	#20 Multi-Con-X	10 through 12	5.0A
	#22	1 through 3	6.0A
		4 through 20	2.5A
		21 through 31	2.5A
	#24	1 through 3	4.5A
		4 through 20	2.0A
21 through 31		1.5A	
#22	#22	4	5.5A
	#24	4	5.0A
#26	#24	5 to 6	4.0A
	#24	7	3.5A
	#26	5 to 6	2.5A
	#26	7	2.5A
	#28*	5 to 6	2.0A
	#28*	7	2.0A

*Not UL tested for this wire conductor size