

# NuWaves

## RF Solutions

### NuPower Xtender™ U-20-C01 900 MHz ISM Bidirectional Amplifier

20 Watt CW

800 MHz to 1000 MHz



P/N: NW-BA-U-20-C01-S01

(includes NW-BA-ACC-CB09MA Standard Interface Cable Assembly)

**The NuPower Xtender™ U-20-C01 is a small, lightweight, and power-efficient bidirectional amplifier ideal for extending the communication range of half-duplex UHF transceivers running constant-envelope or near-constant-envelope waveforms. The bidirectional amplifier generates 20 Watts of RF power from 800 to 1000 MHz in transmit mode and the integrated low-noise amplifier provides a minimum of 13 dB of gain in receive mode.**

Based on the latest gallium nitride (GaN) technology, the Xtender offers greater than 30% power efficiency at most frequencies and its compact size makes it ideal for integration into space-constrained platforms. Adjacent radio frequency bands, such as the popular 900 MHz Industrial, Scientific and Medical (ISM) band, are also supported by the bidirectional PA, at lower peak power levels.

Accepting a +5 dBm RF input, the Xtender provides 38 dB of transmit gain. The Xtender also features over-voltage and reverse-voltage protection and operates over a wide temperature range of -40 to +60 °C.

**Extend your operational communication range with NuPower™ amplifiers from NuWaves RF Solutions.**

#### Features

- 20 Watts RF Output Power
- 800 to 1000 MHz
- Bidirectional Operation
- 38 dB (typ) of Transmit Gain
- 18 dB (typ) Receive Gain LNA
- Fast T/R Mode Switching with Auto-Sensing or Manual T/R Line
- Small Form Factor
- High Efficiency GaN Technology
- Over-Voltage & Reverse-Voltage Protection

#### Applications

- Unmanned Aircraft Systems (UAS) - Group 2 and Group 3
- Unmanned Ground Vehicles (UGV)
- RF Communication Systems
- Software Defined Radios

# NuPower Xtender™ U-20-C01-S01 BDA

## Specifications

### Absolute Maximums

Parameter	Rating	Unit
Max Device Voltage	32	V
Max Device Current	3.5	A
Max RF Input Power, $Z_L = 50 \Omega$	10	dBm
Max Operating Temperature (ambient)	60	°C
Max Operating Temperature (baseplate)	85	°C
Max Storage Temperature	85	°C

Export Classification
EAR99

### Electrical Specifications - Operational @ 28 VDC, 25 °C, $Z_S=Z_L=50 \Omega$

Parameter	Symbol	Min	Typ	Max	Unit	Condition
Operating Frequency	BW	800		1000	MHz	
Switching Speed	$T_{XON/OFF}$		1.5		$\mu$ S	10% to 90%
Operating Voltage	VDC	11	28	32	V	
Operating Current	$I_{DD}$		2.4	2.7	A	CW, Pin = +5 dBm
Module Efficiency			30		%	CW, Pin = +5 dBm

### Electrical Specifications - Transmit @ 28 VDC, 25 °C, $Z_S=Z_L=50 \Omega$ , Conditions at CW, Pin = +5 dBm (unless specified otherwise)

Parameter	Symbol	Min	Typ	Max	Unit	Condition
RF Output Power, Linear	$P_L$		2.5		W	802.11g, 10 MHz BW, 16 QAM
RF Output Power, Psat	Psat		20		W	
Transmit Gain	G		38		dB	
Transmit Gain Flatness	$\Delta G$		2		dB	CW, Pin=-30dBm
2nd Harmonic			-13		dBc	
Nominal Input Drive Level	$P_{IN}$		5		dBm	
Transmit Current	$I_{TX}$		2.4	2.8	A	
Transmit Output Mismatch VSWR				10:1	$\Psi$	no damage at all phase angles
Transmit Input VSWR			3:1			

### Electrical Specifications - Receive @ 28 VDC, 25 °C, $Z_S=Z_L=50 \Omega$

Parameter	Symbol	Min	Typ	Max	Unit	Condition
Receive P1dB	P1dB		14		dBm	
Receive Gain	G	17.5	18		dB	Pin = -30 dBm
Receive Gain Flatness	$\Delta G$		1		dB	
Receive Current	$I_{RX}$		100		mA	
Receive Noise Figure	NF		1.1		dB	

# NuPower Xtender™ U-20-C01-S01 BDA

## Specifications (cont.)

### Mechanical Specifications

Parameter	Value	Unit	Limits
Dimensions	3.0 x 2.0 x 1.16	in	Max
Weight	5.8	oz	Max
RF Connectors, Input/Output	SMA Female		
Interface Connector	Micro-D, 9-pin Socket		
Cooling	Adequate Heatsink Required		

### Environmental Specifications

Parameter	Symbol	Min	Typ	Max	Unit
Operating Temperature (ambient)	$T_A$	-40		+60	°C
Operating Temperature (baseplate)	$T_C$	-40		+85	°C
Storage Temperature	$T_{STG}$	-55		+85	°C
Relative Humidity (non-condensing)	RH			95	%
Altitude MIL-STD-810F - Method 500.4	ALT			30,000	ft
Vibration / Shock Profile (Random profile in x,y, z axis, as per Figure for 15 minute duration in each axis)					

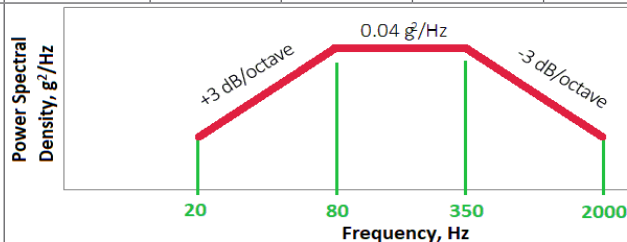

# NuPower Xtender™ U-20-C01-S01 BDA

## Performance Plots (cont.)

Test Conditions: +28 VDC, +25 °C,  $Z_s=Z_L=50 \Omega$

Noise Figure vs. Frequency

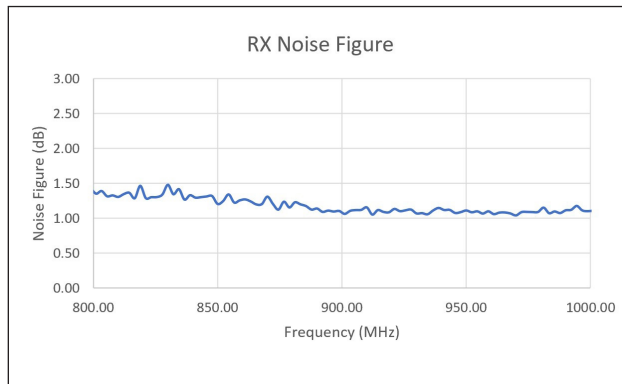

Output Power vs. Input Power

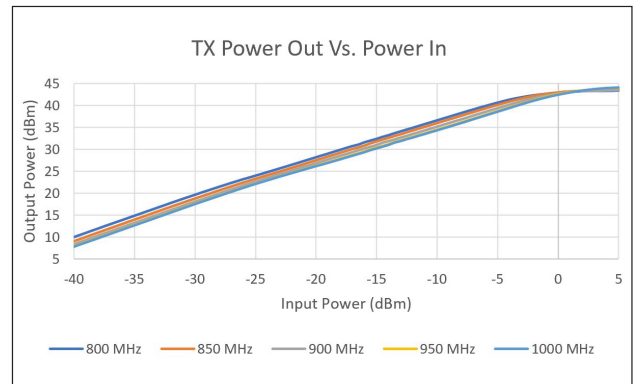

Gain vs. Frequency

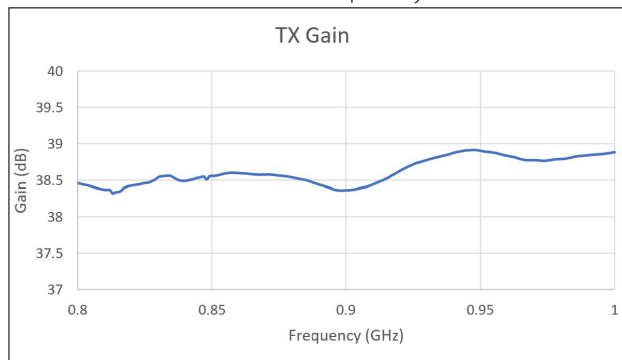

P1dB & P3dB

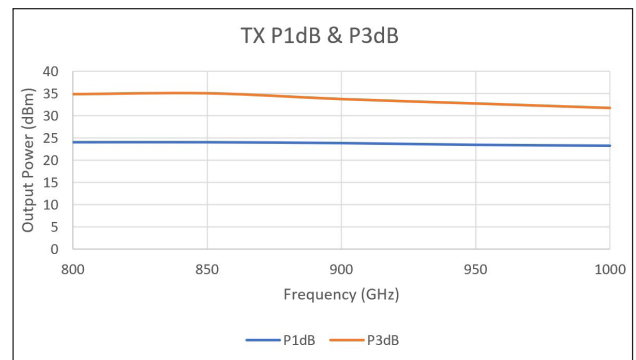

Output Power @ 5dBm Input

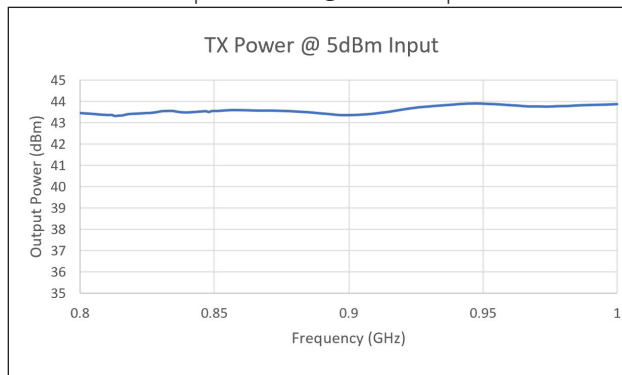

Receive Gain @ -30 dBm Input

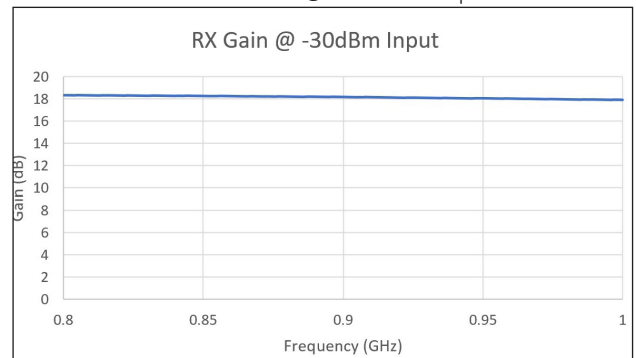

VSWR

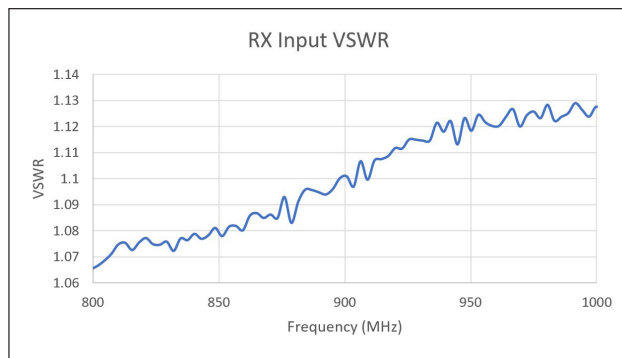

Harmonics (@ Psat)

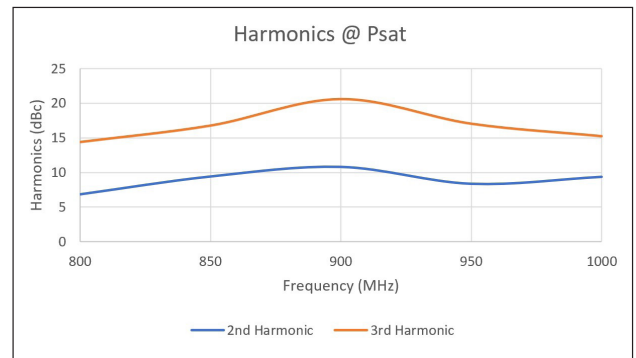

# NuPower Xtender™ U-20-C01-S01 BDA

## Performance Plots (cont.)

Test Conditions: +28 VDC, +25 °C,  $Z_S=Z_L=50 \Omega$

EVM Vs. Input Power (16-QAM 2Msps)

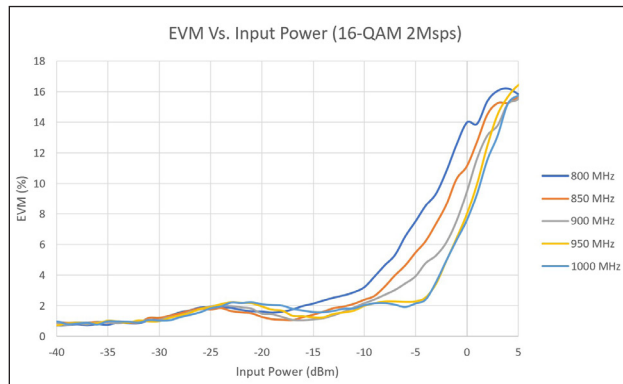

EVM Vs. Output Power (16-QAM 2Msps)

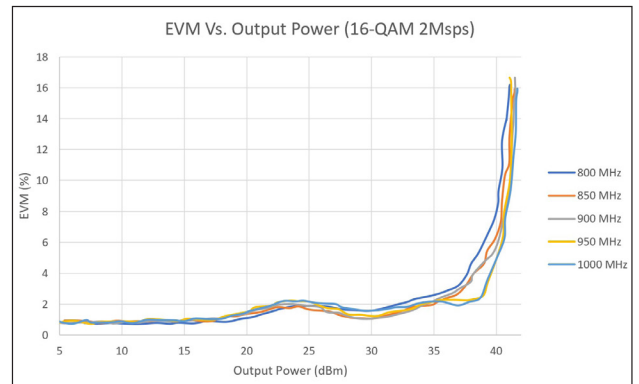

EVM Vs. Input Power (32-QAM 2Msps)

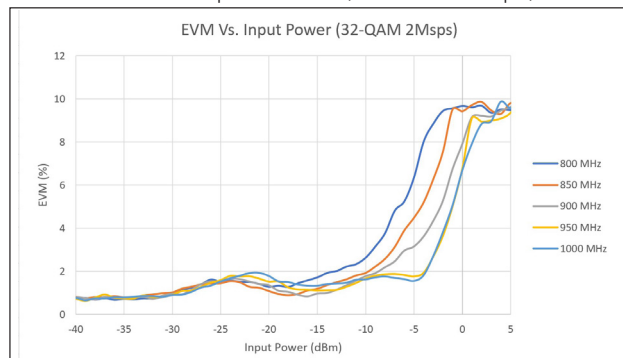

EVM Vs. Output Power (32-QAM 2Msps)

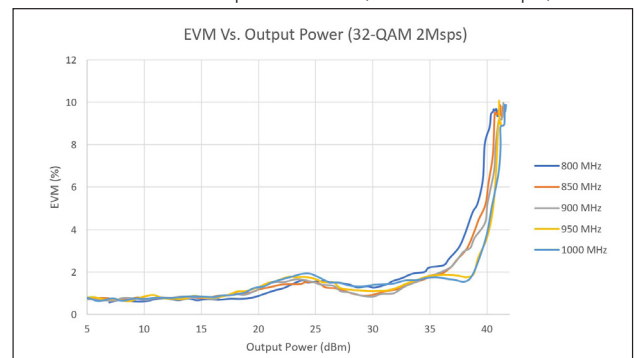

EVM Vs. Input Power (QPSK 2Msps)

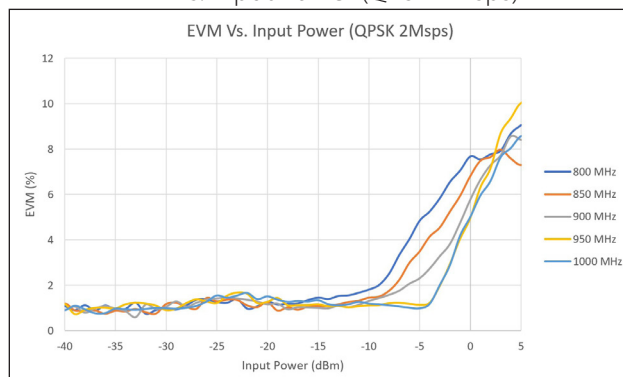

EVM Vs. Output Power (QPSK 2Msps)

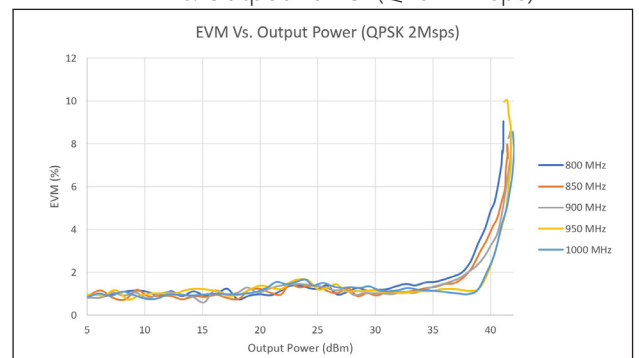

# NuPower Xtender™ U-20-C01-S01 BDA

## Mechanical Outline

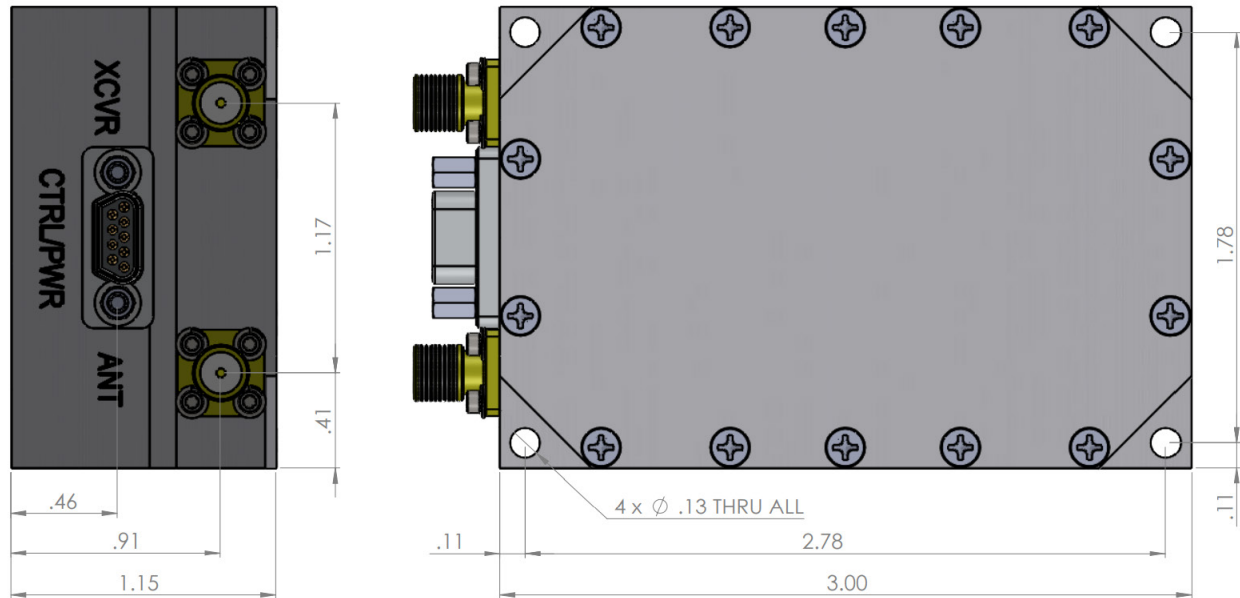

## Accessory Part Numbers

Part Number	Description
NW-FL-05LPLE-2500-SFSF-M01	Harmonic Filter Module
NW-BA-ACC-CB09MA	Standard Interface Cable Assembly - Flying Leads (included with module)
NW-BA-ACC-CT09MA	Upgraded Interface Cable Assembly - Banana Plug Termination
NW-BA-ACC-KT01	Accessory Kit, which includes Fan-Cooled Heatsink and Upgraded Interface Cable
NW-BA-ACC-HS02	Heatsink with Integrated Fan

## Pinout

Function	I/O	Pin
DC Power (+11 to +32 Volts)	I	1, 2, 9
Ground	I	3, 4, 5
RS-485 Data Transmit	O	6
RS-485 Data Receive	I	7
Transmit/Receive Source or Sink	I/O	8

For information on product disposal (end-of-life), please refer to this document: <https://nuwaves.com/wp-content/uploads/Product-Disposal-End-of-Life.pdf>

## Contact NuWaves



NuWaves RF Solutions  
132 Edison Drive  
Middletown, OH 45044

[www.nuwaves.com](http://www.nuwaves.com)  
[sales@nuwaves.com](mailto:sales@nuwaves.com)  
513.360.0800

