

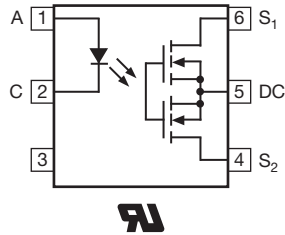

1 Form A Solid-State Relay (Normally Open)

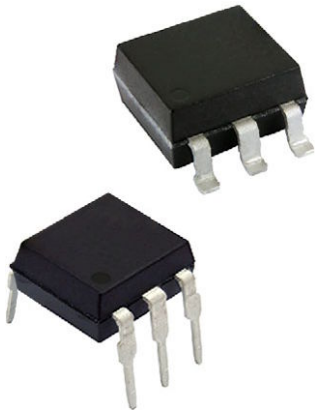

FEATURES

- Current limit protection
- Isolation test voltage 5300 V_{RMS}
- Typical R_{ON} 22 Ω
- Load voltage 350 V
- Load current 140 mA / 250 mA
- High surge capability
- Clean bounce free switching
- Low power consumption
- Material categorization: for definitions of compliance please see www.vishay.com/doc?99912



DESCRIPTION

The LH1500 is robust, ideal for telecom and ground fault applications. It is an SPST normally open switch (1 Form A) that replaces electromechanical relays in many applications. It is constructed using a GaAlAs LED for actuation control and MOSFETs for the switch output. In addition, it employs current-limiting circuitry to provide overvoltage protection.

APPLICATIONS

- General telecom switching
- Security equipment
- Instrumentation
- Industrial controls

AGENCY APPROVALS

- UL1577, file no. E52744

ORDERING INFORMATION												
L	H	1	5	0	0	#	#	#	T	R		
PART NUMBER						ELECTR. VARIATION	PACKAGE CONFIG.	TAPE AND REEL			7.62 mm	> 0.1 mm
PACKAGE						UL						
SMD-6, tube						LH1500AAB						
SMD-6, tape and reel						LH1500AABTR						
DIP-6, tube						LH1500AT						



ABSOLUTE MAXIMUM RATINGS (T _{amb} = 25 °C, unless otherwise specified)				
PARAMETER	CONDITION	SYMBOL	VALUE	UNIT
INPUT				
IRED continuous forward current		I _F	50	mA
IRED reverse voltage		V _R	5	V
Input power dissipation		P _{diss}	80	mW
OUTPUT				
DC or peak AC load voltage		V _L	350	V
Continuous load current (AC/DC configuration)		I _L	140	mA
Continuous load current (DC only configuration)		I _L	250	mA
SSR output power dissipation (continuous)		P _{diss}	550	mW
SSR				
Ambient temperature range		T _{amb}	-40 to +85	°C
Storage temperature range		T _{stg}	-40 to +150	°C
Soldering temperature	t = 10 s max.	T _{slid}	260	°C

Note

- Stresses in excess of the absolute maximum ratings can cause permanent damage to the device. Functional operation of the device is not implied at these or any other conditions in excess of those given in the operational sections of this document. Exposure to absolute maximum ratings for extended periods of the time can adversely affect reliability

ELECTRICAL CHARACTERISTICS (T _{amb} = 25 °C, unless otherwise specified)						
PARAMETER	TEST CONDITION	SYMBOL	MIN.	TYP.	MAX.	UNIT
INPUT						
IRED forward current, switch turn-on	I _L = 100 mA, t = 10 ms	I _{Fon}	-	0.3	2	mA
IRED forward current, switch turn-off	V _L = 350 V	I _{Foff}	0.05	0.15	-	mA
IRED forward voltage	I _F = 10 mA	V _F	-	1.36	1.45	V
OUTPUT						
On-resistance (AC/DC configuration)	I _F = 5 mA, I _L = 50 mA	R _{ON}	-	22	27	Ω
On-resistance (DC only configuration)	I _F = 5 mA, I _L = 100 mA	R _{ON}	-	5.2	7	Ω
Off-resistance	I _F = 0 mA, V _L = ± 100 V	R _{OFF}	0.5	5000	-	GΩ
Off-state leakage current	I _F = 0 mA, V _L = ± 100 V	I _O	-	< 1	200	nA
	I _F = 0 mA, V _L = ± 350 V	I _O	-	6	1000	nA
Output capacitance (AC/DC configuration)	I _F = 0 mA, V _L = 1 V, 1 MHz	C _O	-	39	-	pF
	I _F = 0 mA, V _L = 50 V, 1 MHz	C _O	-	6	-	pF
Current limit (AC/DC configuration) ⁽¹⁾	I _F = 5 mA, t = 5 ms, V _L = ± 6 V	I _{limit}	170	300	450	mA
TRANSFER						
Capacitance (input to output)	V _{ISO} = 1 V	C _{IO}	-	0.4	-	pF

Notes

- Minimum and maximum values are testing requirements. Typical values are characteristics of the device and are the result of engineering evaluations. Typical values are for information only and are not part of the testing requirements

⁽¹⁾ No DC mode current limit available

PIN CONFIGURATION

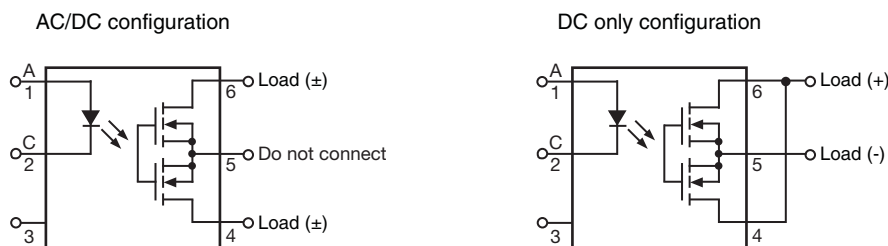

Fig. 1 - Pin Configuration

SWITCHING CHARACTERISTICS ($T_{amb} = 25\text{ }^{\circ}\text{C}$, unless otherwise specified)						
PARAMETER	TEST CONDITION	SYMBOL	MIN.	TYP.	MAX.	UNIT
Turn-on time	$I_F = 5\text{ mA}$, $I_L = 50\text{ mA}$	t_{on}	-	0.13	2	ms
Turn-off time	$I_F = 5\text{ mA}$, $I_L = 50\text{ mA}$	t_{off}	-	0.05	2	ms

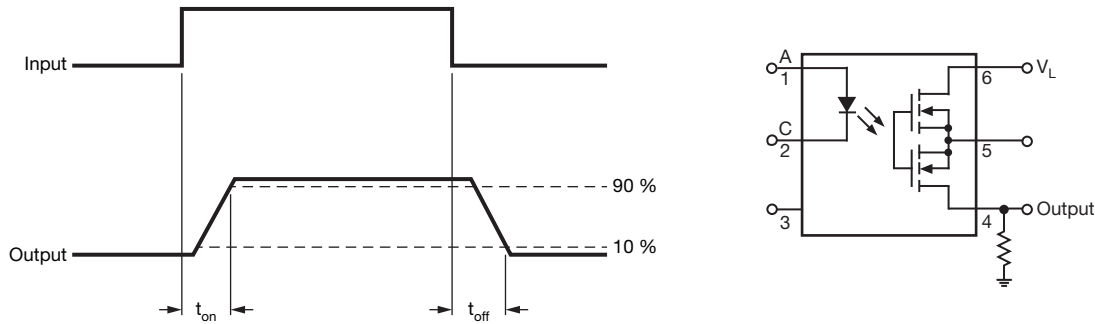

Fig. 2 - Timing Schematic

SAFETY AND INSULATION RATINGS				
PARAMETER	TEST CONDITION	SYMBOL	VALUE	UNIT
Climatic classification	According to IEC 68 part 1		40 / 85 / 21	
Pollution degree	According to DIN VDE 0109		2	
Comparative tracking index	Insulation group IIIa	CTI	175	
Maximum rated withstanding isolation voltage	According to UL1577, $t = 1\text{ min}$	V_{ISO}	5300	V_{RMS}
Maximum transient isolation voltage	According to DIN EN 60747-5-5	V_{IOTM}	8000	V_{peak}
Maximum repetitive peak isolation voltage	According to DIN EN 60747-5-5	V_{IORM}	890	V_{peak}
Isolation resistance	$V_{IO} = 500\text{ V}$, $T_{amb} = 25\text{ }^{\circ}\text{C}$	R_{IO}	$\geq 10^{12}$	Ω
	$V_{IO} = 500\text{ V}$, $T_{amb} = 100\text{ }^{\circ}\text{C}$	R_{IO}	$\geq 10^{11}$	Ω
Output safety power		P_{SO}	700	mW
Input safety current		I_{SI}	240	mA
Safety temperature		T_S	175	$^{\circ}\text{C}$
Creepage distance			≥ 7	mm
Clearance distance			≥ 7	mm
Insulation thickness		DTI	≥ 0.4	mm
Input to output test voltage, method B	$V_{IORM} \times 1.875 = V_{PR}$, 100 % production test with $t_M = 1\text{ s}$, partial discharge $< 5\text{ pC}$	V_{PR}	1669	V_{peak}
Input to output test voltage, method A	$V_{IORM} \times 1.6 = V_{PR}$, 100 % sample test with $t_M = 10\text{ s}$, partial discharge $< 5\text{ pC}$	V_{PR}	1424	V_{peak}

Note

- As per IEC 60747-5-5, § 7.4.3.8.2, this optocoupler is suitable for “safe electrical insulation” only within the safety ratings. Compliance with the safety ratings shall be ensured by means of protective circuits

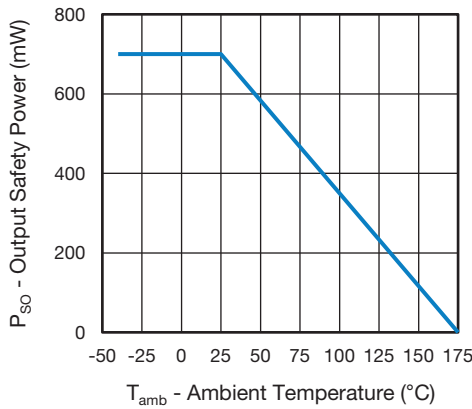

Fig. 3 - Safety Power Dissipation vs. Ambient Temperature

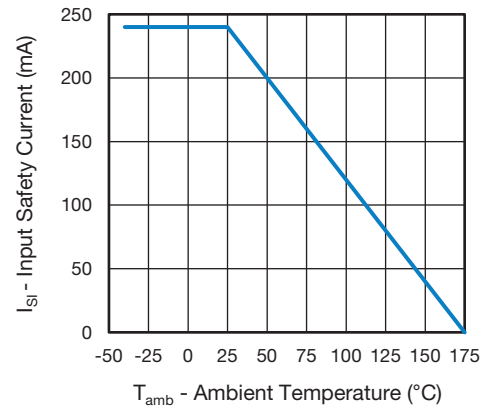

Fig. 4 - Safety Input Current vs. Ambient Temperature

TYPICAL CHARACTERISTICS (T_{amb} = 25 °C, unless otherwise specified)

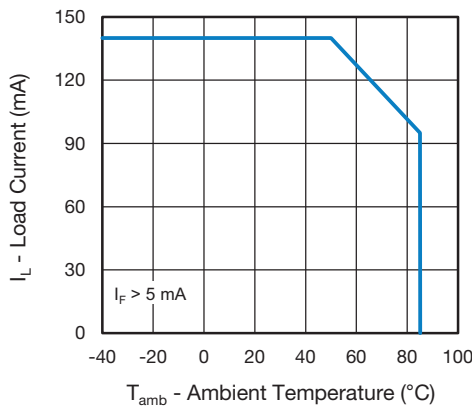

Fig. 5 - Maximum Load Current vs. Ambient Temperature

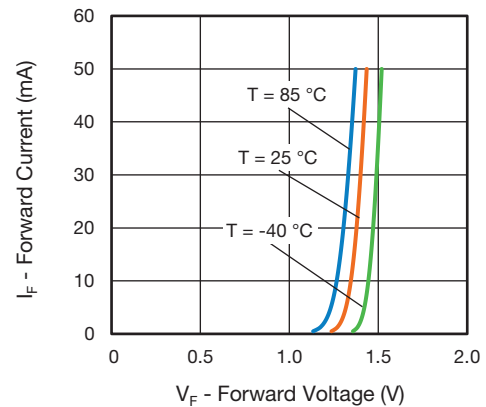

Fig. 7 - Forward Current vs. Forward Voltage

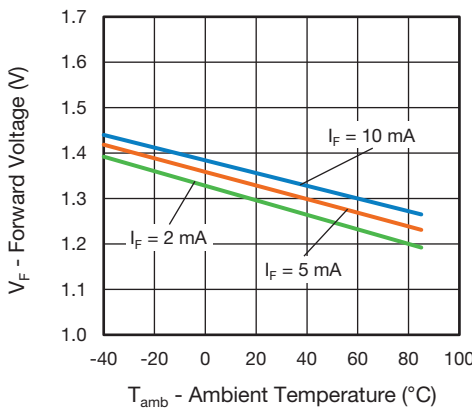

Fig. 6 - Forward Voltage vs. Ambient Temperature

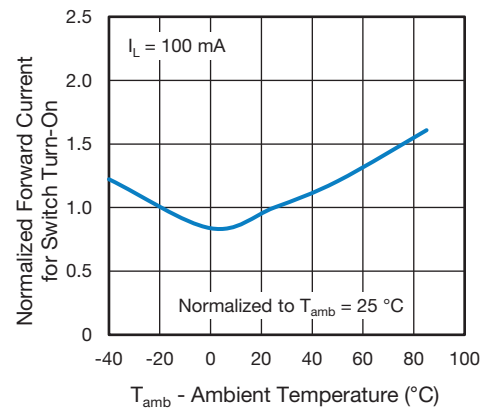

Fig. 8 - Normalized Forward Current for Switch Turn-On vs. Ambient Temperature

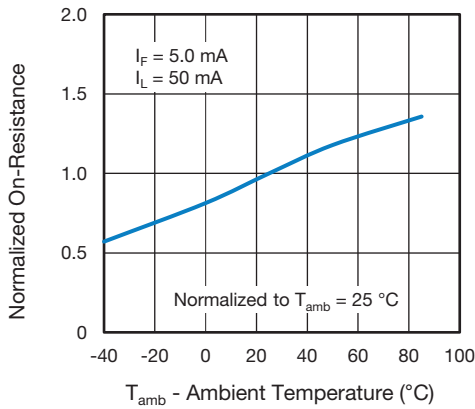

Fig. 9 - Normalized On-Resistance vs. Ambient Temperature

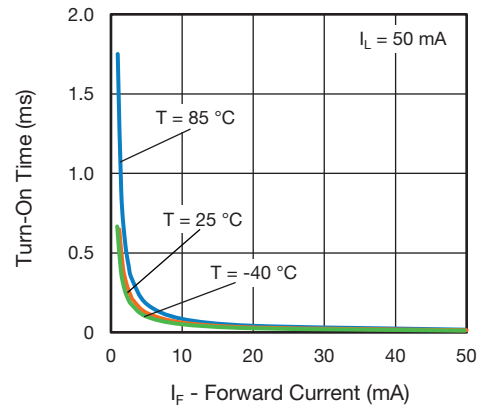

Fig. 12 - Turn-On Time vs. Forward Current

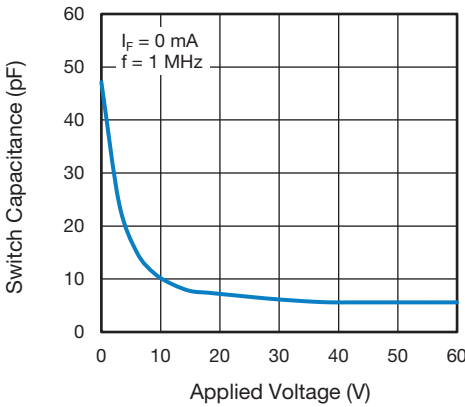

Fig. 10 - Switch Capacitance vs. Applied Voltage

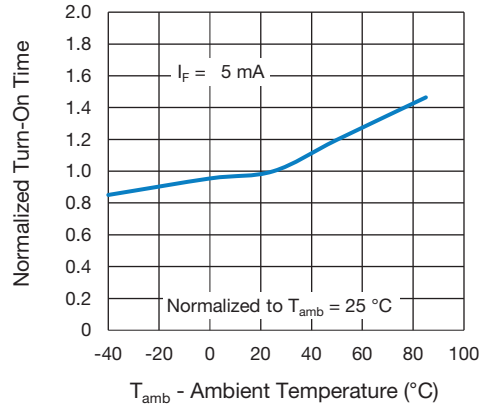

Fig. 13 - Normalized Turn-On Time vs. Ambient Temperature

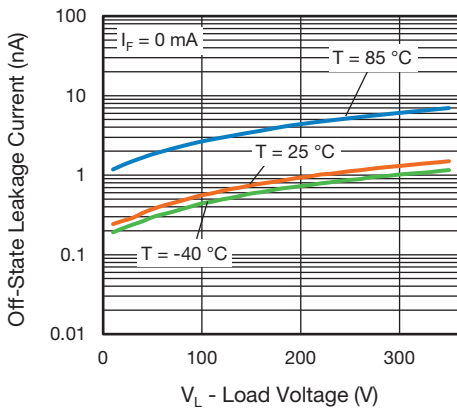

Fig. 11 - Off-State Leakage Current vs. Load Voltage

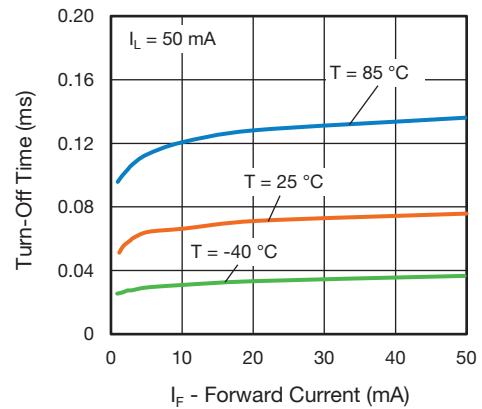

Fig. 14 - Turn-Off Time vs. Forward Current

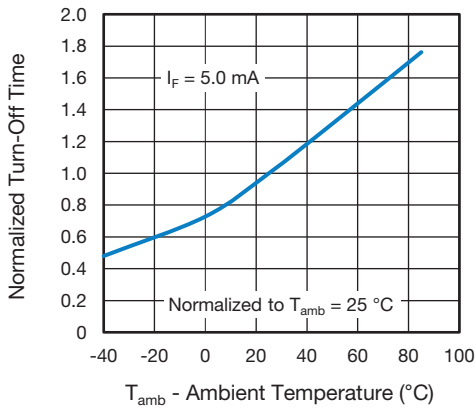
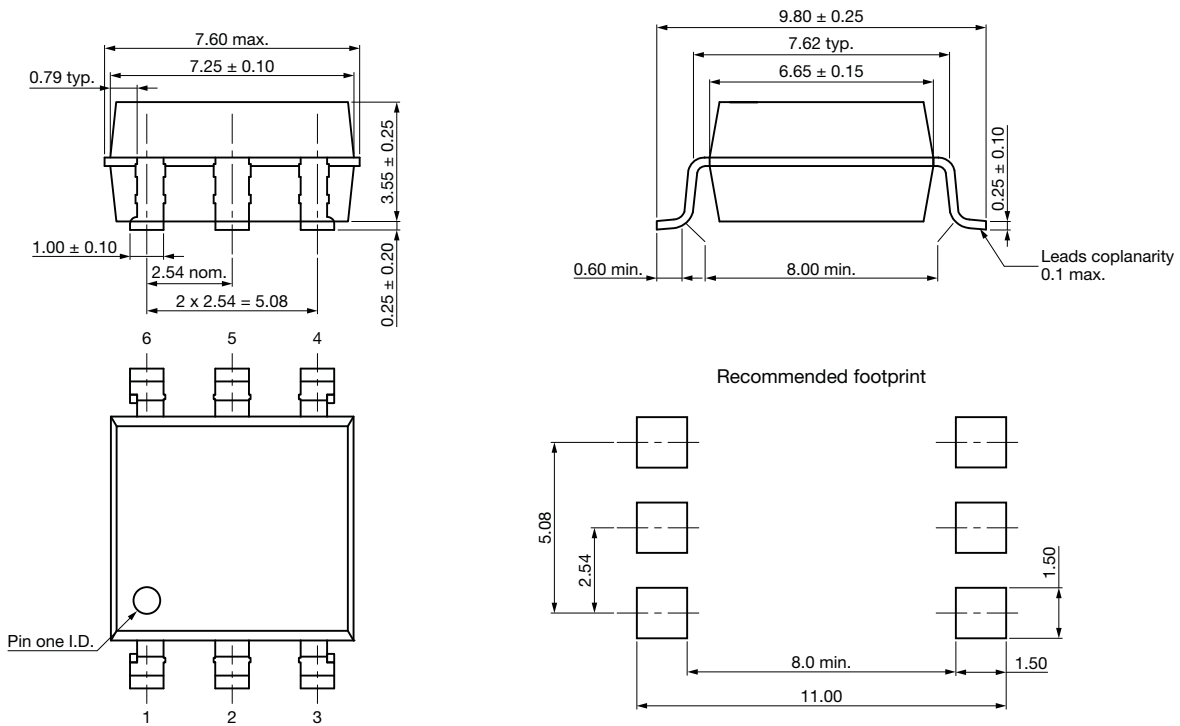

Fig. 15 - Normalized Turn-Off Time vs. Ambient Temperature

PACKAGE DIMENSIONS (in millimeters)

SMD-6



DIP-6

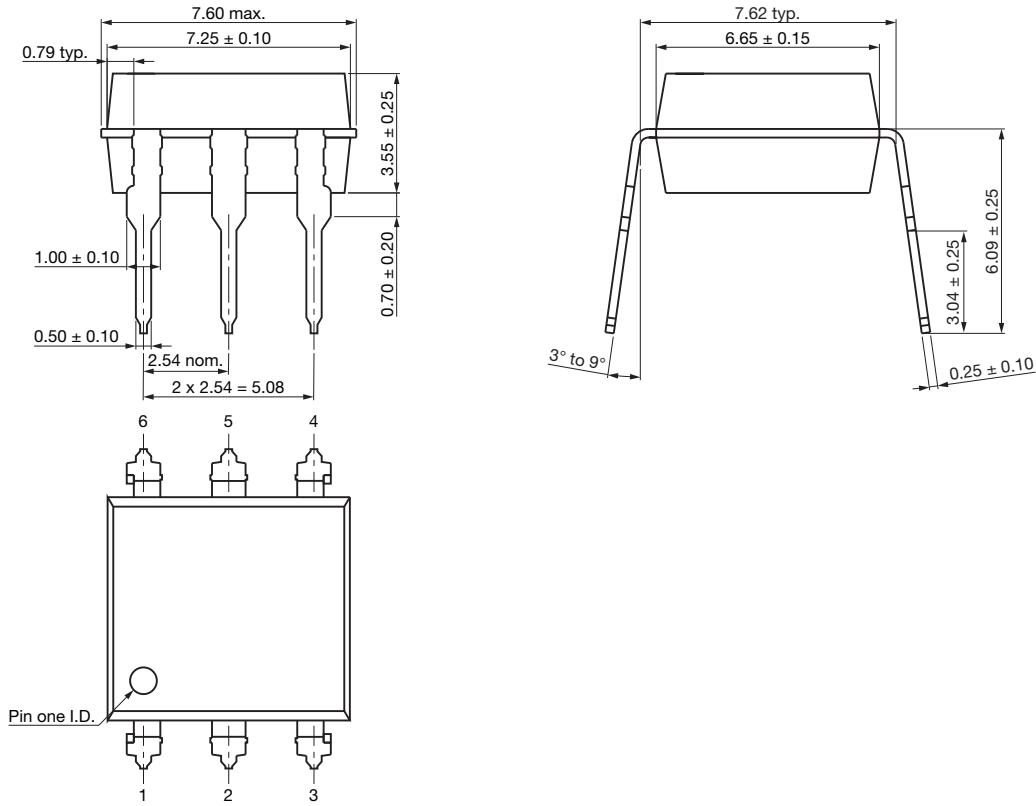

Fig. 16 - Package Drawings

PACKAGE MARKING

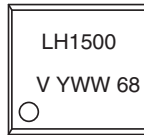
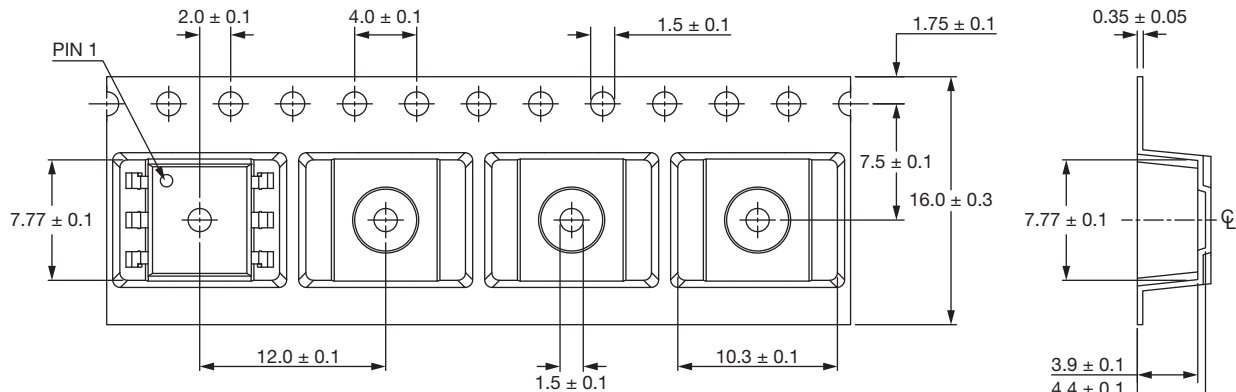

Fig. 17 - LH1500

Note

- Tape and reel suffix (TR) is not part of the package marking

PACKING INFORMATION (in millimeters)



Note:

- Cumulative tolerance of 10 spocket holes is 0.20 mm

Fig. 18 - Tape and Reel Packing

TAPE AND REEL PACKING	
TYPE	UNITS/REEL
SMD-6	1000

TUBE PACKING			
TYPE	UNITS/TUBE	TUBES/BOX	UNITS/BOX
SMD-6	50	40	2000
DIP-6	50	40	2000

SOLDER PROFILES

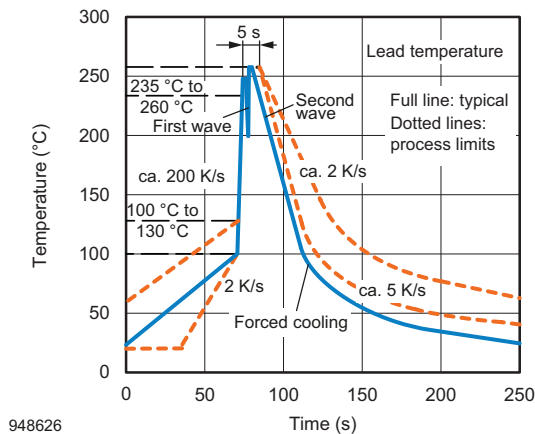

Fig. 19 - Wave Soldering Double Wave Profile According to J-STD-020 for DIP Devices

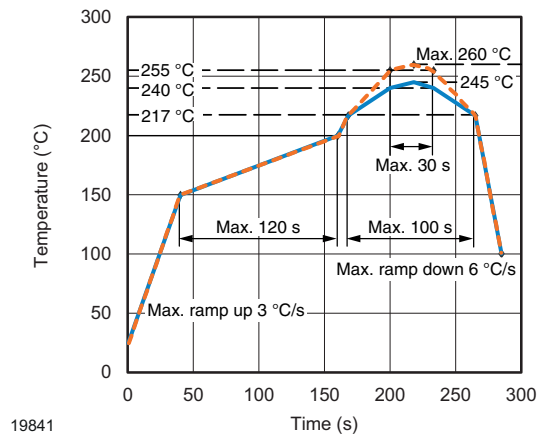

Fig. 20 - Lead (Pb)-free Reflow Solder Profile According to J-STD-020 for SMD Devices

HANDLING AND STORAGE CONDITIONS

ESD level: HBM class 2

Floor life: unlimited

Conditions: $T_{amb} < 30\text{ }^{\circ}\text{C}$, RH < 60 %

Moisture sensitivity level 1, according to J-STD-020



Disclaimer

ALL PRODUCT, PRODUCT SPECIFICATIONS AND DATA ARE SUBJECT TO CHANGE WITHOUT NOTICE TO IMPROVE RELIABILITY, FUNCTION OR DESIGN OR OTHERWISE.

Vishay Intertechnology, Inc., its affiliates, agents, and employees, and all persons acting on its or their behalf (collectively, "Vishay"), disclaim any and all liability for any errors, inaccuracies or incompleteness contained in any datasheet or in any other disclosure relating to any product.

Vishay makes no warranty, representation or guarantee regarding the suitability of the products for any particular purpose or the continuing production of any product. To the maximum extent permitted by applicable law, Vishay disclaims (i) any and all liability arising out of the application or use of any product, (ii) any and all liability, including without limitation special, consequential or incidental damages, and (iii) any and all implied warranties, including warranties of fitness for particular purpose, non-infringement and merchantability.

Statements regarding the suitability of products for certain types of applications are based on Vishay's knowledge of typical requirements that are often placed on Vishay products in generic applications. Such statements are not binding statements about the suitability of products for a particular application. It is the customer's responsibility to validate that a particular product with the properties described in the product specification is suitable for use in a particular application. Parameters provided in datasheets and / or specifications may vary in different applications and performance may vary over time. All operating parameters, including typical parameters, must be validated for each customer application by the customer's technical experts. Product specifications do not expand or otherwise modify Vishay's terms and conditions of purchase, including but not limited to the warranty expressed therein.

Hyperlinks included in this datasheet may direct users to third-party websites. These links are provided as a convenience and for informational purposes only. Inclusion of these hyperlinks does not constitute an endorsement or an approval by Vishay of any of the products, services or opinions of the corporation, organization or individual associated with the third-party website. Vishay disclaims any and all liability and bears no responsibility for the accuracy, legality or content of the third-party website or for that of subsequent links.

Except as expressly indicated in writing, Vishay products are not designed for use in medical, life-saving, or life-sustaining applications or for any other application in which the failure of the Vishay product could result in personal injury or death. Customers using or selling Vishay products not expressly indicated for use in such applications do so at their own risk. Please contact authorized Vishay personnel to obtain written terms and conditions regarding products designed for such applications.

No license, express or implied, by estoppel or otherwise, to any intellectual property rights is granted by this document or by any conduct of Vishay. Product names and markings noted herein may be trademarks of their respective owners.